

2022 / 23 / 24

BUILDPRO[®]



Welding Tables

Metric Catalog

Welding Tables · Platforms · Fixturing Elements · Mobile Working Stations

StrongHandTools[®]

StrongHandTools.com 562.949.8625

BUILDPRO SYSTEM

BuildPro offers a complete line of heavy-duty and ultra-duty tables for work holding in metal fabrication and woodworking. Our tried and tested system is the fastest method of locating and clamping your workpieces. The system consists of a working surface machined with equally spaced boreholes, allowing you to slip-fit clamps, stops, spacers, and other work holding tools into place.



ALPHA TABLES

The new heavy-duty table line from BuildPro; it features 5 sides fitted with 16mm diameter boreholes for more versatility and expandability than before. Maintaining industry-leading requirements for flatness, squareness, and dimensional accuracy. Also available in ultra-duty 28 mm configurations.



MAX TABLES

Our single-sided heavy-duty tables feature boreholes on the top surface and feature patented self-locating and reversible table top plates. Available in standard and nitrided tabletop finishes.



MAX SLOTTED TABLES

Our slotted, single-sided heavy-duty tables feature open slots between the top plates. Providing extra versatility, allowing you to slide clamping tools or pliers using T-Slot adapters or Sliding Channel on the open slot edges as clamping surfaces. Available in standard and nitrided tabletop finishes.

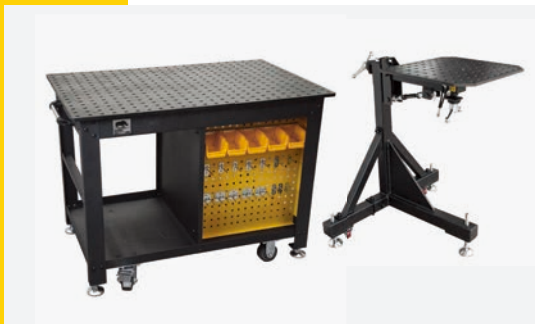

MOBILE WORKING STATIONS

Get the best of both worlds; the functionality and quality of BuildPro tables with the mobility of a cart. The Rhino Cart and Manipulator feature a replaceable heavy-duty tabletop that accepts all 16mm diameter TM fixturing components - giving you the ultimate, compact mobile working stations.

Contents

<p>TABLES & ACCESSORIES 04 - 27</p>							
<p>MOBILE WORKING STATIONS 28 - 32</p>							
<p>PLATFORMS 33 - 35</p>							
<p>CLAMPS & PLIERS 36 - 43</p>							
<p>FASTENERS 44 - 46</p>							
<p>STOPS 47 - 48</p>							
<p>CLAMPING SQUARES 49 - 51</p>							
<p>RESTS 52 - 56</p>							
<p>SPECIAL TOOLS 57 - 62</p>							
<p>FIXTURING KITS 63 - 71</p>							

** All product, product specifications and data are subject to change without notice to improve reliability, function, design or otherwise. Please check online for updated information and details.*



THE NEW FIVE-SIDED ALPHA WELDING TABLE

Introducing the Alpha series, the toughest, flattest, hardest working welding tables from BuildPro by Strong HandTools.

The Alpha family consists of our 5 sided table systems, combined with our patent-exclusive, reversible, and replaceable top and side plates.

Precision ground steel plates, with CNC machined $\varnothing 16$ mm holes in a 50 x 50 mm grid pattern for locating, positioning and mounting BuildPro clamps & accessories.

Plates can be reconfigured to expand the width of the table for larger projects.

Heavy Duty Leveling Feet ensure proper leveling of the table on uneven surfaces.



Increase quality, consistency, and productivity while reducing scrap and setup times for repeating jobs.



ALPHA TABLE OVERVIEW

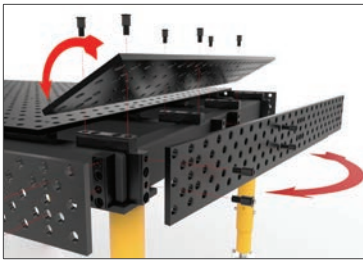

REVERSIBLE Self-Locating Top & Side Plates

All BuildPro welding tables feature precision machined self-locating steel plates and reversible top plates; this enables each table plate to be removed and flipped 180 degrees to expose a new working surface if the top side has been damaged or worn down.

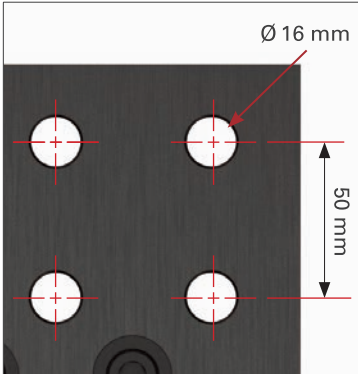

Alpha Table Accuracy

Table flatness: 0.3 mm / 1,000 mm

Hole spacing: 50 mm

Hole diameter: 16 mm

Plate thickness: 12 mm

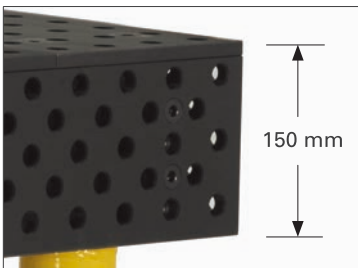

Alpha Tabletop Side Height

The new five-sided tables feature a 138 mm side plate combined with the top plate to create a 150 mm height.

Alpha table side plates feature an extended 5 borehole pattern for added precision and adjust-ability.

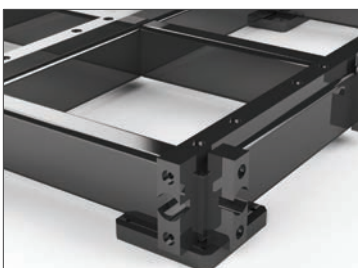

Plate Mounting Detail for Side Plates

Side Plates also use self locating bushing system.



Nitrided (Heat-Treated) Tabletop

All top and side plates of alpha table are constructed from heat-treated steel, hardened to 58-62 HRC(top) / 50-55 HRC(side), and finished with a nitrite coating with a case depth of 0.01 - 0.02 mm.

TABLE SURFACE DIMENSION: 3,000 X 1,500 MM

**All load capacities below are calculated based on static load.*



Part No.	TM603015FP-A1	TM603015FP-A2
Finish	Nitrided	Nitrided
Comes with Leg	6x TML3130	6x TML2530
Table Surface Height (mm)	917	767
Capacity / Leg (kg)	680	680
Gross Weight (kg)	841	834



Part No.	TM603015FP-B1
Finish	Nitrided
Comes with Leg	6x TMLR30
Table Surface Height (mm)	715 ~ 969
Capacity / Leg (kg)	680
Gross Weight (kg)	846



Part No.	TM603015FP-C1
Finish	Nitrided
Comes with Leg	6x TMLC30
Table Surface Height (mm)	835 ~ 1,090
Capacity / Leg (kg)	300
Gross Weight (kg)	861



ALPHA, 3,000 X 1,500 X 150 MM TABLETOP

Part No.	Finish	Dimension (mm)	Gross Weight (kg)
TM603015FP	Nitrided	3,000 x 1,500	802

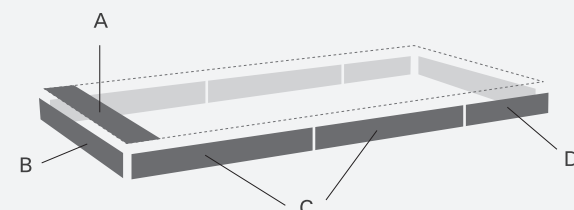

INDIVIDUAL PLATES

Ref.	Part No.	Qty	Dimension (mm)	Weight (kg)	Thickness (mm)
A	TM603015FP-01	15	1,500 x 200	25.9	12
B	TM603015FP-04	2	1,488 x 138	16.7	
C	TM602412FP-03	4	1,200 x 138	13.5	
D	TM603015FP-06	2	588 x 138	7.2	

ALPHA TABLES

TABLE SURFACE DIMENSION: 2,400 X 1,200 MM

**All load capacities below are calculated based on static load.*



Part No.	TM602412FP-A1	TM602412FP-A2
Finish	Nitrided	Nitrided
Comes with Leg	6x TML3130	6x TML2530
Table Surface Height (mm)	917	767
Capacity / Leg (kg)	680	680
Gross Weight (kg)	621	614



Part No.	TM602412FP-B1
Finish	Nitrided
Comes with Leg	6x TMLR30
Table Surface Height (mm)	715 ~ 969
Capacity / Leg (kg)	680
Gross Weight (kg)	626



Part No.	TM602412FP-C1
Finish	Nitrided
Comes with Leg	6x TMLC30
Table Surface Height (mm)	835 ~ 1,090
Capacity / Leg (kg)	300
Gross Weight (kg)	641



ALPHA, 2,400 X 1,200 X 150 MM TABLETOP

Part No.	Finish	Dimension (mm)	Gross Weight (kg)
TM602412FP	Nitrided	2,400 x 1,200	582

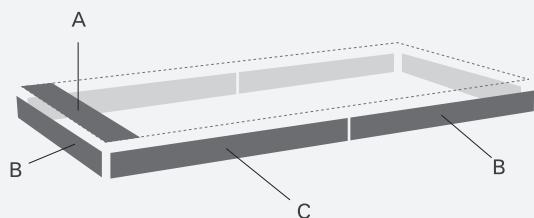

INDIVIDUAL PLATES

Ref.	Part No.	Qty	Dimension (mm)	Weight (kg)	Thickness (mm)
A	TM602412FP-01	12	1,200 x 200	20.7	12
B	TM602412FP-04	4	1,188 x 138	13.4	
C	TM602412FP-03	2	1,200 x 138	13.5	

TABLE SURFACE DIMENSION: 2,000 X 1,000 MM

**All load capacities below are calculated based on static load.*



Part No.	TM602010FP-A1	TM602010FP-A2
Finish	Nitrided	Nitrided
Comes with Leg	6x TML3130	6x TML2530
Table Surface Height (mm)	917	767
Capacity / Leg (kg)	680	680
Gross Weight (kg)	448	441



Part No.	TM602010FP-B1
Finish	Nitrided
Comes with Leg	6x TMLR30
Table Surface Height (mm)	715 ~ 969
Capacity / Leg (kg)	680
Gross Weight (kg)	453



Part No.	TM602010FP-C1
Finish	Nitrided
Comes with Leg	6x TMLC30
Table Surface Height (mm)	835 ~ 1,090
Capacity / Leg (kg)	300
Gross Weight (kg)	468

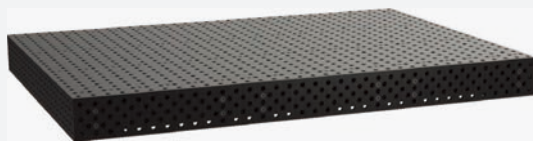

ALPHA, 2,000 X 1,000 X 150 MM TABLETOP

Part No.	Finish	Dimension (mm)	Gross Weight (kg)
TM602010FP	Nitrided	2,000 x 1,000	409

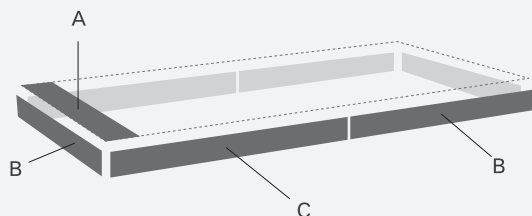

INDIVIDUAL PLATES

Ref.	Part No.	Qty	Dimension (mm)	Weight (kg)	Thickness (mm)
A	TM602010FP-01	10	1,000 x 200	17.5	12
B	TM602010FP-04	4	988 x 138	11.4	
C	TM602010FP-03	2	1,000 x 138	11.5	

ALPHA TABLES

TABLE SURFACE DIMENSION: 1,500 X 1,000 MM

**All load capacities below are calculated based on static load.*



Part No.	TM601510FP-A1	TM601510FP-A2
Finish	Nitrided	Nitrided
Comes with Leg	4x TML3130	4x TML2530
Table Surface Height (mm)	917	767
Capacity / Leg (kg)	680	680
Gross Weight (kg)	327	322



Part No.	TM601510FP-B1
Finish	Nitrided
Comes with Leg	4x TMLR30
Table Surface Height (mm)	715 ~ 969
Capacity / Leg (kg)	680
Gross Weight (kg)	330



Part No.	TM601510FP-C1
Finish	Nitrided
Comes with Leg	4x TMLC30
Table Surface Height (mm)	835 ~ 1,090
Capacity / Leg (kg)	300
Gross Weight (kg)	340



ALPHA, 1,500 X 1,000 X 150 MM TABLETOP

Part No.	Finish	Dimension (mm)	Gross Weight (kg)
TM601510FP	Nitrided	1,500 x 1,000	301

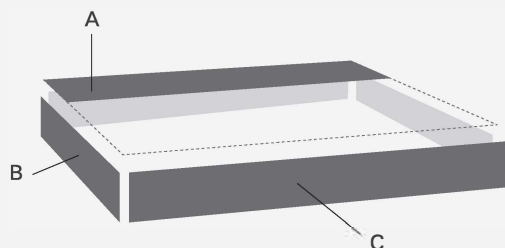

INDIVIDUAL PLATES

Ref.	Part No.	Qty	Dimension (mm)	Weight (kg)	Thickness (mm)
A	TM603015FP-01	5	1,500 x 200	25.9	12
B	TM602010FP-04	2	988 x 138	11.4	
C	TM603015FP-04	2	1,488 x 138	16.7	

TABLE SURFACE DIMENSION: 1,200 X 1,200 MM

**All load capacities below are calculated based on static load.*



Part No.	TM601212FP-A1	TM601212FP-A2
Finish	Nitrided	Nitrided
Comes with Leg	4x TML3130	4x TML2530
Table Surface Height (mm)	917	767
Capacity / Leg (kg)	680	680
Gross Weight (kg)	314	309



Part No.	TM601212FP-B1
Finish	Nitrided
Comes with Leg	4x TMLR30
Table Surface Height (mm)	715 ~ 969
Capacity / Leg (kg)	680
Gross Weight (kg)	317



Part No.	TM601212FP-C1
Finish	Nitrided
Comes with Leg	4x TMLC30
Table Surface Height (mm)	835 ~ 1,090
Capacity / Leg (kg)	300
Gross Weight (kg)	327



ALPHA, 1,200 X 1,200 X 150 MM TABLETOP

Part No.	Finish	Dimension (mm)	Gross Weight (kg)
TM601212FP	Nitrided	1,200 x 1,200	288

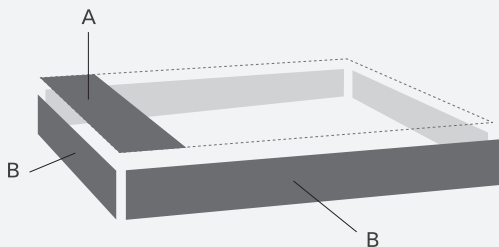

INDIVIDUAL PLATES

Ref.	Part No.	Qty	Dimension (mm)	Weight (kg)	Thickness (mm)
A	TM602412FP-01	6	1,200 x 200	20.7	12
B	TM602412FP-04	4	1,188 x 138	13.4	



Alpha tables available in metric spacing and 28 mm, and 16 mm diameter boreholes, respectively. All top plates are constructed from heat-treated steel, hardened to 58-62 HRC, and finished with a nitrite coating with a case depth of 0.01 - 0.02 mm.

ALPHA 28 TABLES

ALPHA 16 TABLES

	ALPHA 28 TABLES	ALPHA 16 TABLES
Table Hole Dia.	28 mm	16 mm
Hole Spacing	100 mm	50 mm
Table Flatness	0.3 mm / 1,000 mm	0.3 mm / 1,000 mm
Plate Thickness	25 mm	12 mm
Tabletop Side Height	200 mm	150 mm

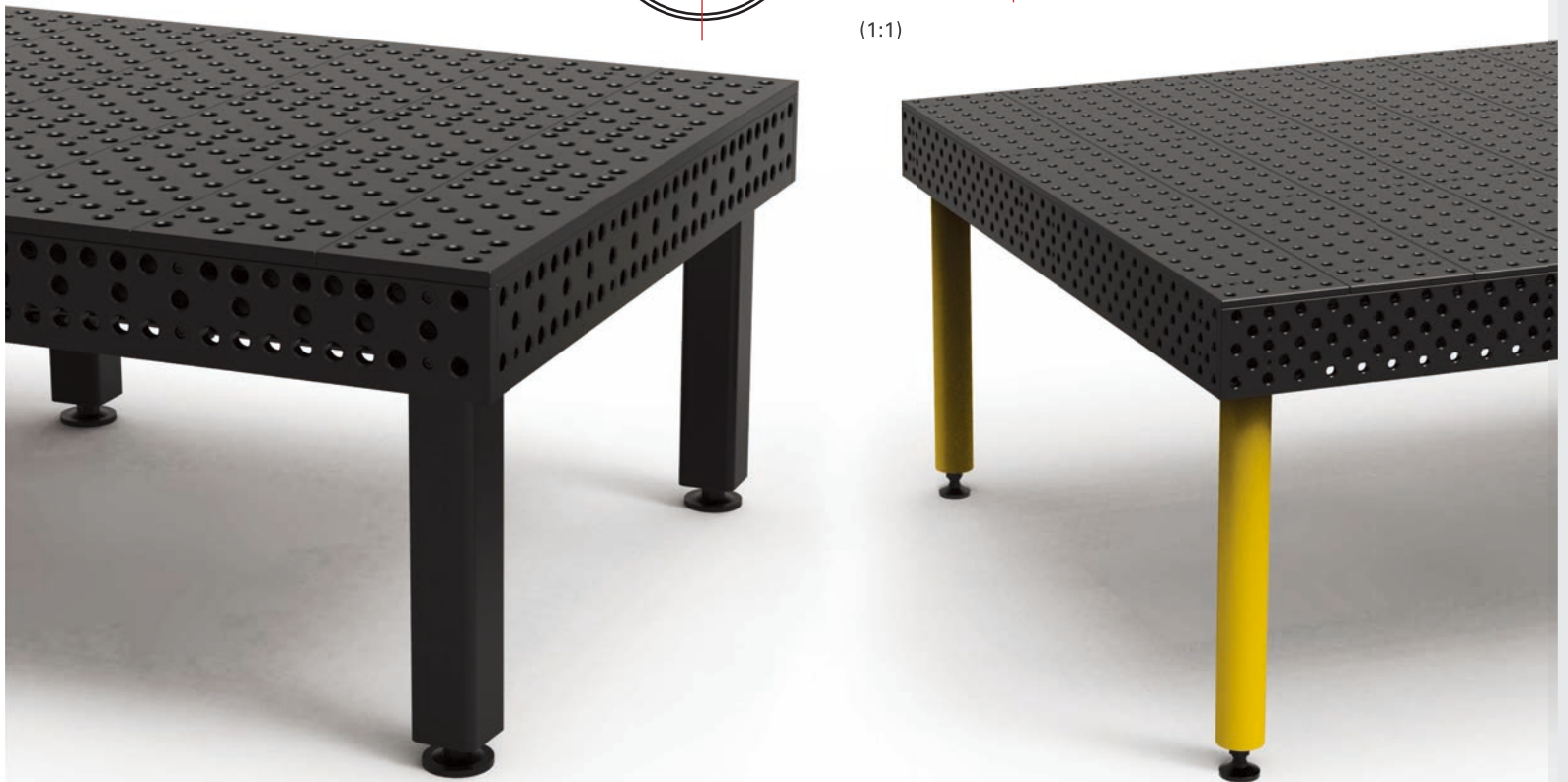
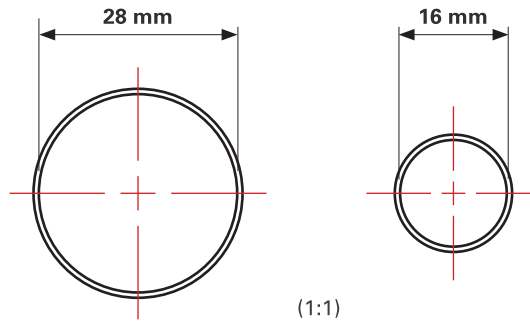

Check our website: buildprotables.com for more details about Alpha 28 table system.

MAX TABLE OVERVIEW

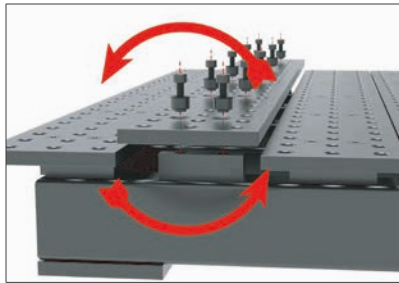

Reversible, Self-Locating Plates

Patented Bushing design allows you to remove, re-position, re-align, and reverse the table plates!

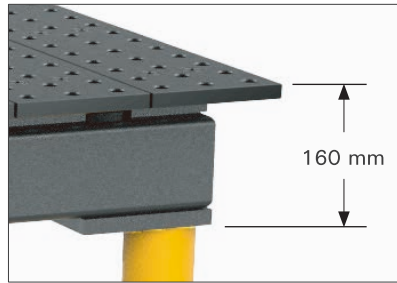

Tabletop Side Height

160 mm for both MAX and MAX Slotted tables

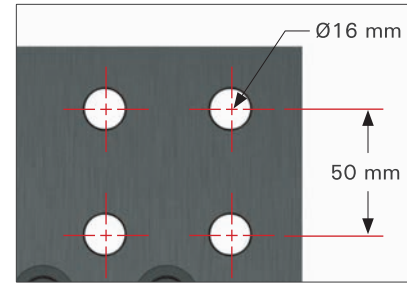

MAX Table Accuracy

Table flatness: 0.3 mm / 1,000 mm
Hole spacing: 50 mm
Hole diameter: 16 mm
Plate thickness: 16 mm



New MAX table sizes available: 1,800 x 1,250 mm & 1,500 x 900 mm

See pg. 15 - 16

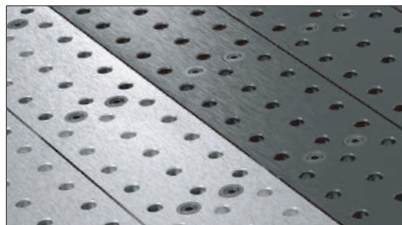

Standard (plain) / Nitrided Finish

Choose from standard finish (medium carbon steel) or Nitrided (heat-treating) finish.

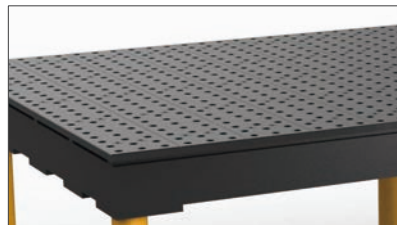

MAX Tables

Maximum Table Surface, Maximum Capacity. Utilize the additional holes (33% more than slotted tables) for clamping at multiple points.



MAX Slotted Tables

All slotted tables have 40 mm slots between plates.

MAX TABLES

U.S. PAT. 8065967

MAX

TABLE SURFACE DIMENSION: 2,550 X 1,250 MM

**All load capacities below are calculated based on static load.*



Part No.	TMD625125V	TME625125V	TMQD625125V	TMQE625125V
Finish	Standard	Standard	Nitrided	Nitrided
Comes with Leg	6x TML3130	6x TML2530	6x TML3130	6x TML2530
Table Surface Height (mm)	927	777	927	777
Capacity / Leg (kg)	680	680	680	680
Gross Weight (kg)	655	650	655	650



Part No.	TMR625125V	TMQR625125V
Finish	Standard	Nitrided
Comes with Leg	6x TMLR30	6x TMLR30
Table Surface Height (mm)	725 ~ 979	725 ~ 979
Capacity / Leg (kg)	680	680
Gross Weight (kg)	660	660



Part No.	TMRC625125V	TMQRC625125V
Finish	Standard	Nitrided
Comes with Leg	6x TMLC30	6x TMLC30
Table Surface Height (mm)	845 ~ 1,100	845 ~ 1,100
Capacity / Leg (kg)	300	300
Gross Weight (kg)	675	675



MAX, 2,550 X 1,250 X 160 MM TABLETOPS

Part No.	Finish	Dimension (mm)	Gross Weight (kg)
TM625125V	Standard	2,550 x 1,250	610
TMQ625125V	Nitrided	2,550 x 1,250	610



INDIVIDUAL PLATES

Part No.	Finish	Qty	Dimension (mm)	Weight (kg)	Thickness (mm)
TM620125V-01	Standard	17	1,250 x 150	21	16
TMQ620125V-01	Nitrided	17	1,250 x 150	21	

TABLE SURFACE DIMENSION: 1,950 X 1,250 MM

**All load capacities below are calculated based on static load.*



Part No.	TMD620125V	TME620125V	TMQD620125V	TMQE620125V
Finish	Standard	Standard	Nitrided	Nitrided
Comes with Leg	6x TML3130	6x TML2530	6x TML3130	6x TML2530
Table Surface Height (mm)	927	777	927	777
Capacity / Leg (kg)	680	680	680	680
Gross Weight (kg)	490	485	490	485



Part No.	TMR620125V	TMQR620125V
Finish	Standard	Nitrided
Comes with Leg	6x TMLR30	6x TMLR30
Table Surface Height (mm)	725 ~ 979	725 ~ 979
Capacity / Leg (kg)	680	680
Gross Weight (kg)	495	495



Part No.	TMRC620125V	TMQRC620125V
Finish	Standard	Nitrided
Comes with Leg	6x TMLC30	6x TMLC30
Table Surface Height (mm)	845 ~ 1,100	845 ~ 1,100
Capacity / Leg (kg)	300	300
Gross Weight (kg)	515	515



MAX, 1,950 X 1,250 X 160 MM TABLETOPS

Part No.	Finish	Dimension (mm)	Gross Weight (kg)
TM620125V	Standard	1,950 x 1,250	460
TMQ620125V	Nitrided	1,950 x 1,250	460



INDIVIDUAL PLATES

Part No.	Finish	Qty	Dimension (mm)	Weight (kg)	Thickness (mm)
TM620125V-01	Standard	13	1,250 x 150	21	16
TMQ620125V-01	Nitrided	13	1,250 x 150	21	

MAX TABLES

U.S. PAT. 8065967

MAX

TABLE SURFACE DIMENSION: 1,800 X 1,250 MM

*All load capacities below are calculated based on static load.



Part No.	TMD618125V	TME618125V	TMQD618125V	TMQE618125V
Finish	Standard	Standard	Nitrided	Nitrided
Comes with Leg	6x TML3130	6x TML2530	6x TML3130	6x TML2530
Table Surface Height (mm)	927	777	927	777
Capacity / Leg (kg)	680	680	680	680
Gross Weight (kg)	475	468	475	468



Part No.	TMR618125V	TMQR618125V
Finish	Standard	Nitrided
Comes with Leg	6x TMLR30	6x TMLR30
Table Surface Height (mm)	725 ~ 979	725 ~ 979
Capacity / Leg (kg)	680	680
Gross Weight (kg)	480	480



Part No.	TMRC618125V	TMQRC618125V
Finish	Standard	Nitrided
Comes with Leg	6x TMLC30	6x TMLC30
Table Surface Height (mm)	845 ~ 1,100	845 ~ 1,100
Capacity / Leg (kg)	300	300
Gross Weight (kg)	495	495

MAX, 1,800 X 1,250 X 160 MM TABLETOPS



Part No.	Finish	Dimension (mm)	Gross Weight (kg)
TM618125V	Standard	1,800 x 1,250	435
TMQ618125V	Nitrided	1,800 x 1,250	435

INDIVIDUAL PLATES



Part No.	Finish	Qty	Dimension (mm)	Weight (kg)	Thickness (mm)
TM620125V-01	Standard	12	1,250 x 150	21	16
TMQ620125V-01	Nitrided	12	1,250 x 150	21	

TABLE SURFACE DIMENSION: 1,500 X 900 MM

**All load capacities below are calculated based on static load.*



Part No.	TMD61509V	TME61509V	TMQD61509V	TMQE61509V
Finish	Standard	Standard	Nitrided	Nitrided
Comes with Leg	6x TML3130	6x TML2530	6x TML3130	6x TML2530
Table Surface Height (mm)	927	777	927	777
Capacity / Leg (kg)	680	680	680	680
Gross Weight (kg)	315	308	315	308



Part No.	TMR61509V	TMQR61509V
Finish	Standard	Nitrided
Comes with Leg	6x TMLR30	6x TMLR30
Table Surface Height (mm)	725 ~ 979	725 ~ 979
Capacity / Leg (kg)	680	680
Gross Weight (kg)	320	320



Part No.	TMRC61509V	TMQRC61509V
Finish	Standard	Nitrided
Comes with Leg	6x TMLC30	6x TMLC30
Table Surface Height (mm)	845 ~ 1,100	845 ~ 1,100
Capacity / Leg (kg)	300	300
Gross Weight (kg)	335	335

MAX, 1,500 X 900 X 160 MM TABLETOPS



Part No.	Finish	Dimension (mm)	Gross Weight (kg)
TM61509V	Standard	1,500 x 900	275
TMQ61509V	Nitrided	1,500 x 900	275

INDIVIDUAL PLATES



Part No.	Finish	Qty	Dimension (mm)	Weight (kg)	Thickness (mm)
TM615090V-01	Standard	10	900 x 150	15.5	16
TMQ615090V-01	Nitrided	10	900 x 150	15.5	

MAX TABLES

U.S. PAT. 8065967

MAX

TABLE SURFACE DIMENSION: 1,200 X 1,200 MM

*All load capacities below are calculated based on static load.



Part No.	TMD61212V	TME61212V	TMQD61212V	TMQE61212V
Finish	Standard	Standard	Nitrided	Nitrided
Comes with Leg	4x TML3130	4x TML2530	4x TML3130	4x TML2530
Table Surface Height (mm)	927	777	927	777
Capacity / Leg (kg)	680	680	680	680
Gross Weight (kg)	318	312	318	312



Part No.	TMR61212V	TMQR61212V
Finish	Standard	Nitrided
Comes with Leg	4x TMLR30	4x TMLR30
Table Surface Height (mm)	725 ~ 979	725 ~ 979
Capacity / Leg (kg)	680	680
Gross Weight (kg)	321	321



Part No.	TMRC61212V	TMQRC61212V
Finish	Standard	Nitrided
Comes with Leg	4x TMLB1203	4x TMLB1203
Table Surface Height (mm)	845 ~ 1,100	845 ~ 1,100
Capacity / Leg (kg)	300	300
Gross Weight (kg)	332	332



MAX, 1,200 X 1,200 X 160 MM TABLETOPS

Part No.	Finish	Dimension (mm)	Gross Weight (kg)
TM61212V	Standard	1,200 x 1,200	290
TMQ61212V	Nitrided	1,200 x 1,200	290



INDIVIDUAL PLATES

Part No.	Finish	Qty	Dimension (mm)	Weight (kg)	Thickness (mm)
TM61212V-01	Standard	8	1,200 x 150	20	16
TMQ61212V-01	Nitrided	8	1,200 x 150	20	

MODULAR FORM TABLES WITH SQUARE LEGS

* All load capacities below are calculated based on static load. ** Table flatness: 0.75 mm / 1,000 mm.

Developed by customer demand, the Modular Form Tables are the ideal size for use as a space-saving stand-alone fixturing table or joined in a customized configuration [in size and shape] for each unique project.

Connecting Modular Form Tables using Square Table Legs (Part No.: TMLS31 & TMLS25) + Connecting Screws underneath each table corner.

New Single Plate Design

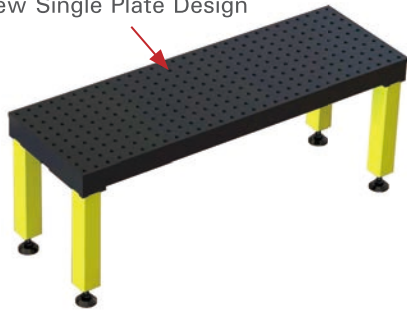

500 X 1,500 MM



700 X 1,000 MM

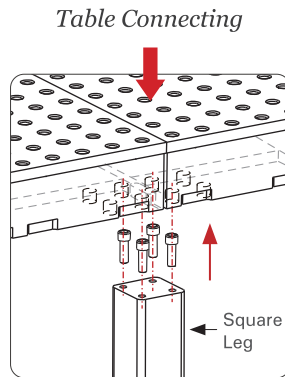

1,000 X 1,500 MM



700 X 1,500 MM

Part No.	Finish	Table Surface Height (mm)	Tabletop Dimension (mm)	Capacity (kg)	Table Weight (kg)
TMQSD60515F	Nitrided	877	500 x 1,500	800 per leg	168
TMQSE60515F		727			162
TMQSD61015F		877	1,000 x 1,500		283
TMQSE61015F		727			277
TMQSD60710F		877	700 x 1,000		163
TMQSE60710F		727			157
TMQSD60715F		877	700 x 1,500		213
TMQSE60715F		727			207

MODULAR TABLETOPS

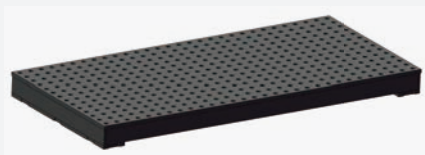

Part No.	Finish	Tabletop Dimension (mm)	Weight (kg)
TMQ60515F	Nitrided	500 x 1,500 x 100	130
TMQ61015F		1,000 x 1,500 x 100	245
TMQ60710F		700 x 1,000 x 100	125
TMQ60715F		700 x 1,500 x 100	175

SLOTTED TABLES

U.S. PAT. 8065967

TABLE SURFACE DIMENSION: 2,560 X 1,250 MM

*All load capacities below are calculated based on static load.

SLOTTED



Part No.	TMD625125SV	TME625125SV	TMQD625125SV	TMQE625125SV
Finish	Standard	Standard	Nitrided	Nitrided
Comes with Leg	6x TML3130	6x TML2530	6x TML3130	6x TML2530
Table Surface Height (mm)	927	777	927	777
Capacity / Leg (kg)	680	680	680	680
Gross Weight (kg)	450	435	450	435



Part No.	TMR625125SV	TMQR625125SV
Finish	Standard	Nitrided
Comes with Leg	6x TMLR30	6x TMLR30
Table Surface Height (mm)	725 ~ 979	725 ~ 979
Capacity / Leg (kg)	680	680
Gross Weight (kg)	455	455



Part No.	TMRC625125SV	TMQRC625125SV
Finish	Standard	Nitrided
Comes with Leg	6x TMLC30	6x TMLC30
Table Surface Height (mm)	845 ~ 1,100	845 ~ 1,100
Capacity / Leg (kg)	300	300
Gross Weight (kg)	470	470

SLOTTED, 2,560 X 1,250 X 160 MM TABLETOPS

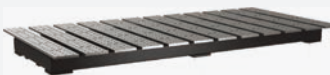

Part No.	Finish	Dimension (mm)	Gross Weight (kg)
TM625125SV	Standard	2,560 x 1,250	410
TMQ625125SV	Nitrided	2,560 x 1,250	410

INDIVIDUAL PLATES



Part No.	Finish	Qty	Dimension (mm)	Weight (kg)	Thickness (mm)
TM620125SV-01	Standard	13	1,250 x 160	23	16
TMQ620125SV-01	Nitrided	13	1,250 x 160	23	

TABLE SURFACE DIMENSION: 1,960 X 1,150 MM

**All load capacities below are calculated based on static load.*

SLOTTED



Part No.	TMD62011SV	TME62011SV	TMQD62011SV	TMQE62011SV
Finish	Standard	Standard	Nitrided	Nitrided
Comes with Leg	6x TML3130	6x TML2530	6x TML3130	6x TML2530
Table Surface Height (mm)	927	777	927	777
Capacity / Leg (kg)	680	680	680	680
Gross Weight (kg)	356	349	356	349



Part No.	TMR62011SV	TMQR62011SV
Finish	Standard	Nitrided
Comes with Leg	6x TMLR30	6x TMLR30
Table Surface Height (mm)	725 ~ 979	725 ~ 979
Capacity / Leg (kg)	680	680
Gross Weight (kg)	360	360



Part No.	TMRC62011SV	TMQRC62011SV
Finish	Standard	Nitrided
Comes with Leg	6x TMLC30	6x TMLC30
Table Surface Height (mm)	845 ~ 1,100	845 ~ 1,100
Capacity / Leg (kg)	300	300
Gross Weight (kg)	375	375

SLOTTED, 1,960 X 1,150 X 160 MM TABLETOPS

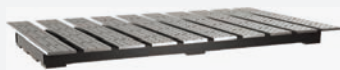

Part No.	Finish	Dimension (mm)	Gross Weight (kg)
TM62011SV	Standard	1,960 x 1,150	315
TMQ62011SV	Nitrided	1,960 x 1,150	315

INDIVIDUAL PLATES



Part No.	Finish	Qty	Dimension (mm)	Weight (kg)	Thickness (mm)
TM62011SV-01	Standard	10	1,150 x 160	22	16
TMQ62011SV-01	Nitrided	10	1,150 x 160	22	

SLOTTED TABLES

U.S. PAT. 8065967

TABLE SURFACE DIMENSION: 1,960 X 1,000 MM

*All load capacities below are calculated based on static load.

SLOTTED



Part No.	TMD62010SV	TME62010SV	TMQD62010SV	TMQE62010SV
Finish	Standard	Standard	Nitrided	Nitrided
Comes with Leg	6x TML3130	6x TML2530	6x TML3130	6x TML2530
Table Surface Height (mm)	927	777	927	777
Capacity / Leg (kg)	680	680	680	680
Gross Weight (kg)	316	309	316	309



Part No.	TMR62010SV	TMQR62010SV
Finish	Standard	Nitrided
Comes with Leg	6x TMLR30	6x TMLR30
Table Surface Height (mm)	725 ~ 979	725 ~ 979
Capacity / Leg (kg)	680	680
Gross Weight (kg)	320	320



Part No.	TMRC62010SV	TMQRC62010SV
Finish	Standard	Nitrided
Comes with Leg	6x TMLC30	6x TMLC30
Table Surface Height (mm)	845 ~ 1,100	845 ~ 1,100
Capacity / Leg (kg)	300	300
Gross Weight (kg)	335	335

SLOTTED, 1,960 X 1,000 X 160 MM TABLETOPS



Part No.	Finish	Dimension (mm)	Gross Weight (kg)
TM62010SV	Standard	1,960 x 1,000	275
TMQ62010SV	Nitrided	1,960 x 1,000	275

INDIVIDUAL PLATES



Part No.	Finish	Qty	Dimension (mm)	Weight (kg)	Thickness (mm)
TM62010SV-01	Standard	10	1,000 x 160	18	16
TMQ62010SV-01	Nitrided	10	1,000 x 160	18	

TABLE SURFACE DIMENSION: 1,160 X 1,150 MM

**All load capacities below are calculated based on static load.*

SLOTTED



Part No.	TMD61211SV	TME61211SV	TMQD61211SV	TMQE61211SV
Finish	Standard	Standard	Nitrided	Nitrided
Comes with Leg	4x TML3130	4x TML2530	4x TML3130	4x TML2530
Table Surface Height (mm)	927	777	927	777
Capacity / Leg (kg)	680	680	680	680
Gross Weight (kg)	217	211	217	211



Part No.	TMR61211SV	TMQR61211SV
Finish	Standard	Nitrided
Comes with Leg	4x TMLR30	4x TMLR30
Table Surface Height (mm)	725 ~ 979	725 ~ 979
Capacity / Leg (kg)	680	680
Gross Weight (kg)	220	220



Part No.	TMRC61211SV	TMRC61211SV
Finish	Standard	Nitrided
Comes with Leg	4x TMLC30	4x TMLC30
Table Surface Height (mm)	845 ~ 1,100	845 ~ 1,100
Capacity / Leg (kg)	300	300
Gross Weight (kg)	230	230

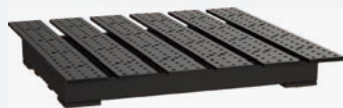

SLOTTED, 1,160 X 1,150 X 160 MM TABLETOPS

Part No.	Finish	Dimension (mm)	Gross Weight (kg)
TM61211SV	Standard	1,160 x 1,150	190
TMQ61211SV	Nitrided	1,160 x 1,150	190



INDIVIDUAL PLATES

Part No.	Finish	Qty	Dimension (mm)	Weight (kg)	Thickness (mm)
TM62011SV-01	Standard	6	1,150 x 160	22	16
TMQ62011SV-01	Nitrided	6	1,150 x 160	22	

SLOTTED TABLES

U.S. PAT. 8065967

TABLE SURFACE DIMENSION: 1,160 X 1,000 MM

*All load capacities below are calculated based on static load.

SLOTTED



Part No.	TMD61210SV	TME61210SV	TMQD61210SV	TMQE61210SV
Finish	Standard	Standard	Nitrided	Nitrided
Comes with Leg	4x TML3130	4x TML2530	4x TML3130	4x TML2530
Table Surface Height (mm)	927	777	927	777
Capacity / Leg (kg)	680	680	680	680
Gross Weight (kg)	195	191	195	191



Part No.	TMR61210SV	TMQR61210SV
Finish	Standard	Nitrided
Comes with Leg	4x TMLR30	4x TMLR30
Table Surface Height (mm)	725 ~ 979	725 ~ 979
Capacity / Leg (kg)	680	680
Gross Weight (kg)	198	198



Part No.	TMRC61210SV	TMQRC61210SV
Finish	Standard	Nitrided
Comes with Leg	4x TMLC30	4x TMLC30
Table Surface Height (mm)	845 ~ 1,100	845 ~ 1,100
Capacity / Leg (kg)	300	300
Gross Weight (kg)	205	205



SLOTTED, 1,160 X 1,000 X 160 MM TABLETOPS

Part No.	Finish	Dimension (mm)	Gross Weight (kg)
TM61210SV	Standard	1,160 x 1,000	165
TMQ61210SV	Nitrided	1,160 x 1,000	165



INDIVIDUAL PLATES

Part No.	Finish	Qty	Dimension (mm)	Weight (kg)	Thickness (mm)
TM62010SV-01	Standard	6	1,000 x 160	18	16
TMQ62010SV-01	Nitrided	6	1,000 x 160	18	

TABLE SURFACE DIMENSION: 560 X 1,000 MM

**All load capacities below are calculated based on static load.*

SLOTTED



Part No.	TMD60610SV	TME60610SV	TMQD60610SV	TMQE60610SV
Finish	Standard	Standard	Nitrided	Nitrided
Comes with Leg	4x TML3130	4x TML2530	4x TML3130	4x TML2530
Table Surface Height (mm)	927	777	927	777
Capacity / Leg (kg)	680	680	680	680
Gross Weight (kg)	115	111	115	111



Part No.	TMR60610SV	TMQR60610SV
Finish	Standard	Nitrided
Comes with Leg	4x TMLR30	4x TMLR30
Table Surface Height (mm)	725 ~ 979	725 ~ 979
Capacity / Leg (kg)	680	680
Gross Weight (kg)	118	118



Part No.	TMRC60610SV	TMQRC60610SV
Finish	Standard	Nitrided
Comes with Leg	4x TMLC30	4x TMLC30
Table Surface Height (mm)	845 ~ 1,100	845 ~ 1,100
Capacity / Leg (kg)	300	300
Gross Weight (kg)	125	125



SLOTTED, 560 X 1,000 X 160 MM TABLETOPS

Part No.	Finish	Dimension (mm)	Gross Weight (kg)
TM60610SV	Standard	560 x 1,000	88
TMQ60610SV	Nitrided	560 x 1,000	88



INDIVIDUAL PLATES

Part No.	Finish	Qty	Dimension (mm)	Weight (kg)	Thickness (mm)
TM62010SV-01	Standard	3	1,000 x 160	18	16
TMQ62010SV-01	Nitrided	3	1,000 x 160	18	



TABLE PLATE MOUNTING KITS

- For Alpha 16 tables

8 pc. of M12 screws for mounting table top or side plates to the table frame.



* This kit is designed for Alpha 16 tables only.



Part No.	Description	Weight (kg)
TY5-M12-8K	8x M12 Mounting Screws	0.27

- For MAX tables

The kit includes 10 pc. of 22 mm O.D. locating bushings and 10 pc. of M10 x 22 mounting screws.

Locating Bushings allow you to remove, re-position, re-align, and reverse the table plates! Must be used in conjunction with mounting screws.



x 10

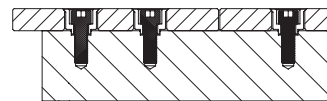
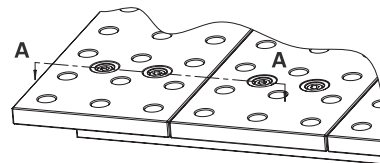

SECTION A-A

Part No.	Description	Weight (kg)
TM62010-04	Locating Bushing for table plate mounting, 22 mm O.D.	0.02
T55310	10 pc. of M10 x 22 Mounting Socket Head Cap Screws	0.3
TM62010-04-10K	10x Locating Bushing + 10x Mounting Screws	0.5



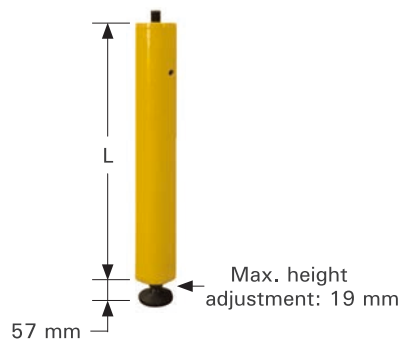

HEAVY DUTY TABLE LEGS

These legs feature steel leveling pads to ensure proper leveling of your table on uneven surfaces. They create a comfortable, safe working height just for you.

Part No.	Dia. (mm)	Thread	Leg Height - L (mm)	* L + Leveling Pad Height (mm)	Weight (kg)
TML3130	76	M20	710	767	6.8
TML2530	76	M20	560	617	5.5

* Table Leg + Leveling Pad height is based on Leveling Pad height of 57 mm.



ADJUSTABLE LEGS

Adjustable at 25 mm increments. Telescoping adjustable range (L) from 508 mm to 762 mm in height.

Part No.	Description	Dia. (mm)	Leg Adjustable Range - L (mm)	L + Leveling Pad / Caster Height (mm)	Weight (kg)
TMLR30	Adjustable Leg	76	508 ~ 762	565 ~ 819	7.5
TMLC30	Adjustable Leg with caster	76	508 ~ 762	685 ~ 939	10.2



SUPPORT LEG ADAPTER

Use the Support Leg Adapter + a BuildPro[®] Table Leg (M20 thread) to support extended table plates at the uniform table height. Screw the table leg into the threaded base of the Support Leg Adapter. Attach the Support Leg Adapter and Leg assembly to the extended table plate using two flush mount socket head shoulder screws (included with Leg Adapter).

Part No.	Description	Dia. (mm)	Weight (kg)
TMLA7	Leg Adapter to support plate extensions and reconfigurations. <i>(Legs sold separately.)</i>	76	2.8

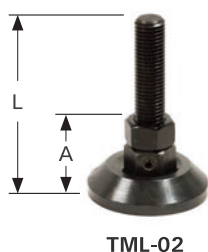

LEVELING PAD

Add Leveling Pad Feet to your BuildPro[®] Tabletop to create a low height table.

Maximum height adjustment: 19 mm.

Part No.	L (mm)	A (mm)	Base Dia. (mm)	Thread	Pitch (mm)	Weight (kg)
TML-02	120	57	76	M20	2.5	0.8

TABLE ACCESSORIES

LEVELING CASTER



These compact, heavy duty leveling casters are the simple way to move and level your BuildPro® Welding Table.

This caster will add about 60 mm to your total tabletop surface height.

* Sold individually.

Part No.	Capacity (kg)	Thread	Weight (kg)
TMLC600	500 each	M20	1.9

MOBILITY CASTER

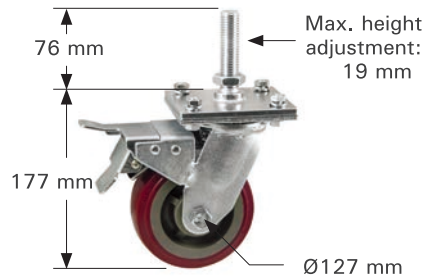

Durable caster rolls smoothly on precision ball bearings, with non-marking, non-marring nylon polymer wheels. Dual toe-step braking system can be set for "no-swivel + no-roll".

This caster will add about 130 mm to your total tabletop surface height.

* Sold individually.

Part No.	Capacity (kg)	Thread	Weight (kg)
TMLC700	300 each	M20	3.5

LEG BRACES

Fit all 76 mm dia. legs. Leg Braces reinforce and stabilize the BuildPro® table.

Ideal as a base for creating shelves. Place a metal plate or wooden board on the brace framework. Create one, or multiple level shelves with additional Leg Brace Assembly.



Part No.	Leg Brace Assembly for				Weight (kg)
	Table	Table Size (mm)	Legs Type	Leg Dia. (mm)	
TMLB2630	MAX	2,550 x 1,250	Heavy Duty & Adjustable	76	11.8
	Slotted	2,560 x 1,250			
TMLB2030	MAX	1,950 x 1,250			10.8
TMLB1830	MAX	1,800 x 1,250			10.0
TMLB1530	MAX	1,500 x 900			6.5
TMLB1203	MAX	1,200 x 1,200			6.8
TMLBR20	Slotted	1,960 x 1,150 & 1,960 x 1,000			10.0
TMLBR12	Slotted	1,160 x 1,150 & 1,160 x 1,000			6.8
TMLBR06	Slotted	560 x 1,000	5.9		

RHINO CART OVERVIEW

Quickly clamp and fixture at any point on the surface. Accurately setup stock for each new project.

- Surface ground for flatness on both sides and reversible
- Heat Treated (Nitrided) for wear and spatter resistance



STRONG HAND TOOLS
PATENTED
ALL RIGHTS RESERVED
U.S. PAT. 9896117

Tabletop Size:	1,200 x 750 mm
Top Plate Thickness:	16 mm
Tabletop Flatness:	0.5 mm / 1,000 mm
Hole Diameter:	16 mm
Grid Pattern:	50 x 50 mm
Table Height:	910 mm
Static Loading Capacity:	680 kg

RHINO CART OVERVIEW

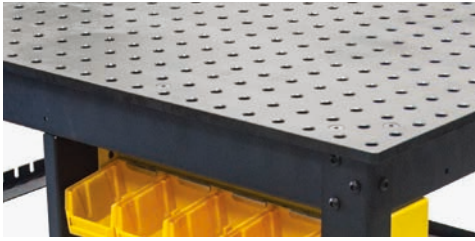

Reversible Tabletop

Nitrided and black oxide table plate is **REVERSIBLE**. Weld spatter, rust and scratch resistant.



CNC Hole Pattern

Accurately position parts in CNC precision bored 16 mm diameter holes in 50 x 50 mm spacing pattern.



Locking Casters

Steel legs are equipped with 2x locking casters + 2x leveling feet for mobile or stationary use.



Store & Organize

Shelves, racks, and a pegboard panel allow you to store, organize, and keep clamps and accessories within reach.



Additional Accessories (sold separately)

Attach the fold-up Plasma Cutting Tray or Hitch Mount Plate to your Rhino Cart® Mobile Fixturing Station to cut, clamp, fixture and weld on one convenient workstation.



Compatible with 16 mm Fixturing Elements

The Rhino Cart® Tabletop is compatible with all BuildPro® Clamps, Components, and Modular Fixturing Kits *except Sliding Channel Clamps, Sliding Channel Bases, Slot filler Kit and T-Slot Adapter.*

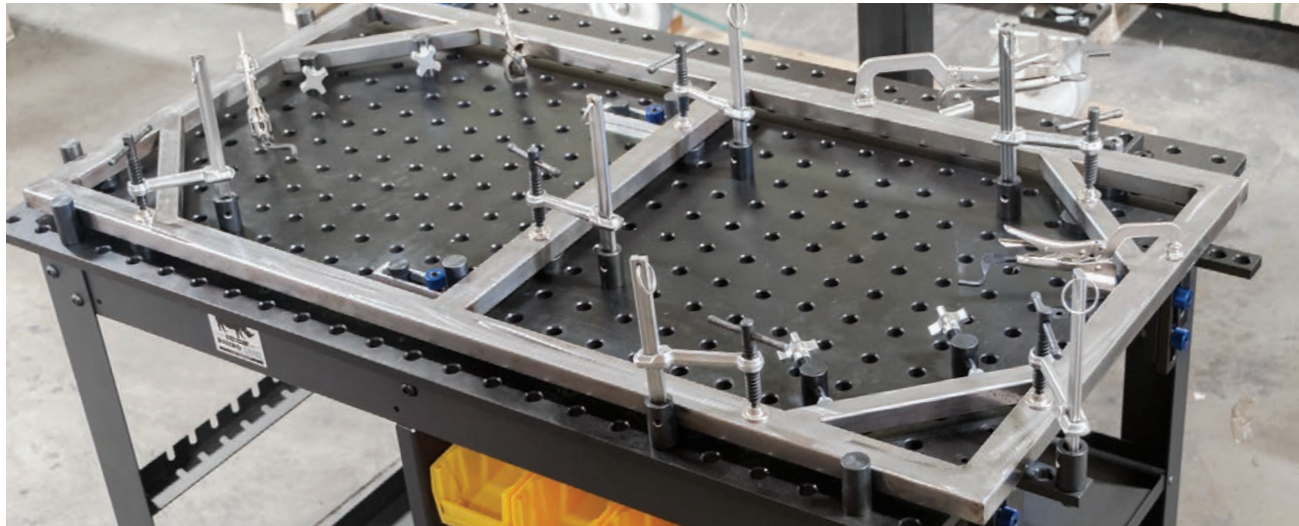

Part No.	Description	Gross Weight (kg)
TDQ612075	Welding Table Only	210
TDQ612075-K1	Welding Table (TDQ612075) + 66 pc. Fixturing Kit (TDK6100)	220
TDQ612075-K2	Welding Table (TDQ612075) + 122 pc. Fixturing Kit (TDK6200)	238
TDQ612075-TT	Tabletop	126
TDQ612075-TF	Tabletop w/ Frame	150

RHINO CART ACCESSORIES

PLASMA CUTTING TRAY



TPL7653

The Plasma Cutting Tray supports 45 kg, on a 450 x 710 cutting surface with 14 reversible / replaceable steel slats. Generous 45mm width between cutting slats provides ample space for hold-down clamping. The fold-out Plasma Cutting Tray easily folds down flat against the Rhino Cart® when not in use. Slats remain secured in place when tray is folded.

Cut, clamp and fixture on one convenient mobile work station at the ideal, uniform working height.



* This accessory is designed for Rhino Cart only.



TPLK3021

Part No.	Cutting Area (mm)	Holding Capacity (kg)	Weight (kg)
TPL7653	450 x 710	45	14.5
TPLK3021	14 Reversible / Replaceable Slats		4.5



HITCH MOUNT PLATE



Mount under the Rhino Cart® table with flush mount screws (included) to create a firm, stable platform to mount your equipments.

Accommodates a three or four hole mounting base pattern.



* This accessory is designed for Rhino Cart only.

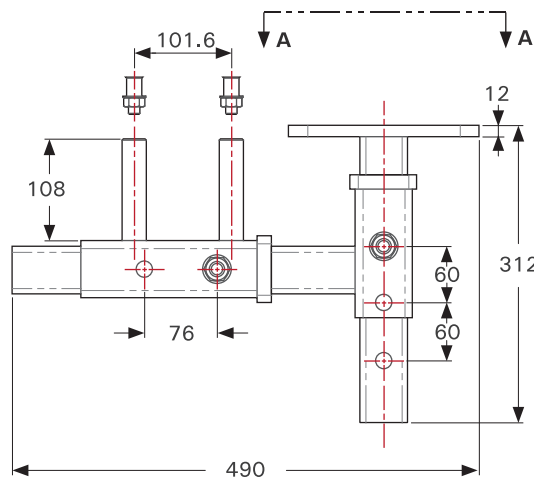
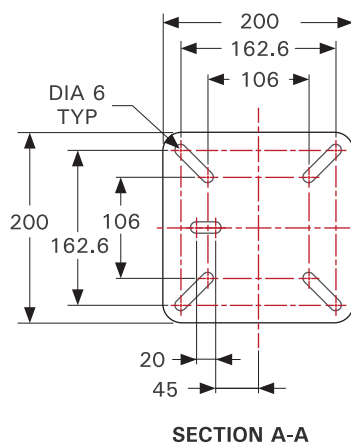

Part No.	Weight (kg)
TXH8022	11



* Vises not included.



The manipulator uses two rotating axis and one tilting axis to position your work in the ideal spot. For best results, always position the center of gravity of the work piece in line with the two rotating axis to achieve low resistance repositioning.

- Access difficult joints without putting yourself in an awkward position
- Position the joint for fastest technique. Go from vertical up or overhead to a flat or downhill weld. Get the job finished with less mental and physical fatigue.
- Fast repositioning. No need to un-clamp.

** We also offer a 30-pc. fixturing kit (TUK6300) to make your set up on the new manipulator fast and accurate, minimize variables for repeat jobs. See pg. 71 for kit details.*

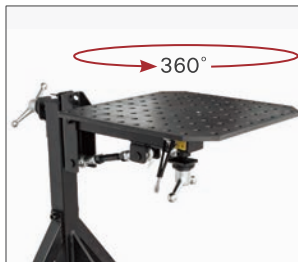

Horizontal Rotary Axis



Vertical Rotary Axis



15° fine adjustment



Spring loaded carbon brush grounds rotating plate to stationary grounding point.



Three Locking Positions - 0° and 30° on both sides.



Two large handles for quick & easy adjustment of rotary axis



Two casters for quick repositioning of manipulator.



Large leveling pads with wrench flats

Part No.	H x L x W (mm)	Top Plate Size (mm)	Hole Dia. (mm)	Capacity (kg)	Gross Weight (kg)
TU65050	1015 x 940 x 940	508 x 508 x 12	16	50	103



TABLE PLATFORM



TABLES & ACCESSORIES

MOBILE WORKING STATIONS

PLATFORMS

FIXTURE ELEMENTS

SPECIAL TOOLS

KITS

ROTARY POSITIONERS

Mount your BuildPro® or Alpha 28 Welding Tabletop to the BuildPro® Rotary Positioner for plane rotation of your work surface. The low backlash gear drive allows for smooth operation, stability, and controlled turning and positioning.

The worm gears combined with center of gravity positioning minimizes the effort required for rotation while preventing free rotation of the table from gravity. A faceplate with 15° increments provides positive manual locking. The BuildPro® Rotary Positioner allows you to rotate your weld fixture to the best ergonomic position for worker safety, comfort, and reduced operator fatigue.

The BuildPro® Rotary Positioner is universal, with an adjustable base to accommodate most standard BuildPro® or Alpha 28 Welding Tabletops. The Positioner features four swiveling, locking casters, and four leveling feet for setup at dedicated or alternating locations in the shop.

* Positioner Capacity: 1,100 kg.

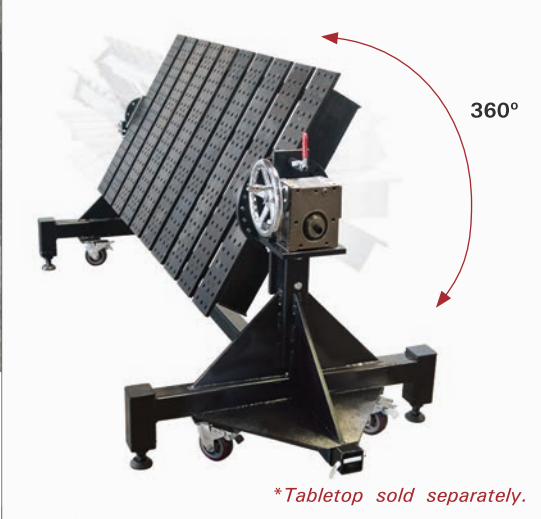

**Tabletop sold separately.*

Table Mounting Brackets

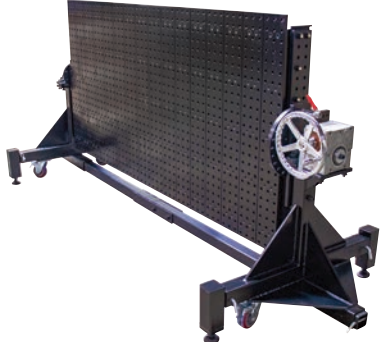
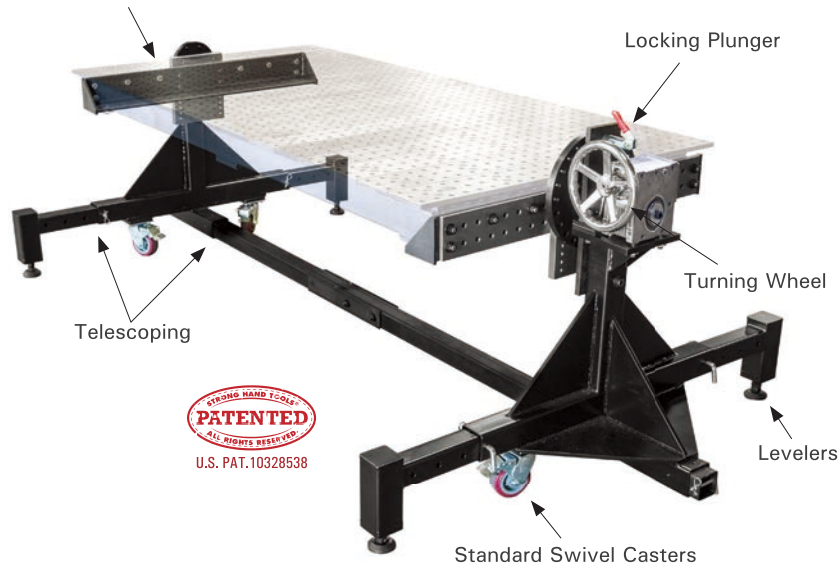

** For use with Alpha 28 Tabletops, contact our Sales Team: sales@stronghandtools.com*

ROTARY POSITIONERS



Our new adjustable outriggers allow greater stability when working with taller assemblies and can be retracted when not required.

Adjustment plates help shift the center of gravity in 25.4 mm increments when working with tall or heavy parts. This allows smoother rotation of assemblies up to 90° from horizontal.

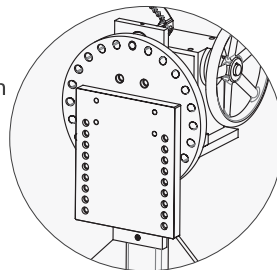

Adjustment plates included.

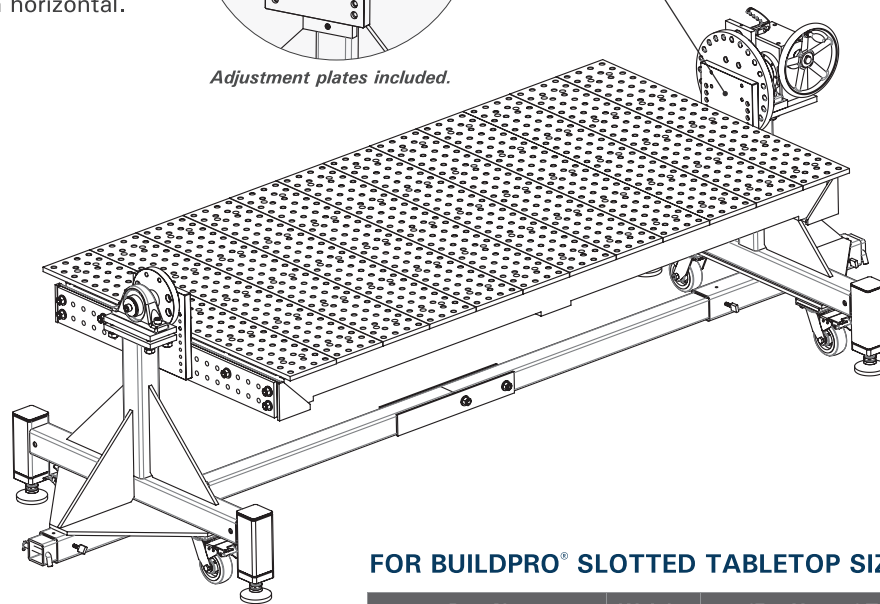

FOR BUILDPRO® MAX TABLETOP SIZE

Part No. (Positioner + Mounting Brackets)	Weight (kg)	(For Use w/ Tabletop) (mm)
TMP625125	460	TM(Q)625125V (2,550 x 1,250)
TMP620125	456	TM(Q)620125V (1,950 x 1,250)
TMP61212	451	TM(Q)61212V (1,200 x 1,200)

FOR BUILDPRO® SLOTTED TABLETOP SIZE

Part No. (Positioner + Mounting Brackets)	Weight (kg)	(For Use w/ Tabletop) (mm)
TMP625125	460	TM(Q)625125SV (2,560 x 1,250)
TMP62010	455	TM(Q)62011SV (1,960 x 1,150) TM(Q)62010SV (1,960 x 1,000)
TMP61210	449	TM(Q)61211SV (1,160 x 1,150) TM(Q)61210SV (1,160 x 1,000)

*Tabletop sold separately.

KEY ELEMENTS in the BuildPro® Modular Fixturing System

NEW DESIGN



*** Ball Lock Bolt**
- An essential component in Modular Fixturing!

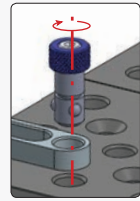

Finger tighten the knurled head after insertion to preload before tightening with Hex Key.

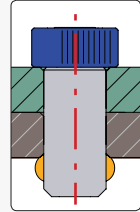

Three locking steel balls move outward to lock the bolt in position.

Ball Lock Bolts are key to the efficient set up of Modular Fixtures on your BuildPro® Tabletop. Use the Ball Lock Bolts to fasten clamping elements to the BuildPro® Tabletop, or fasten two clamping elements together.

Basic Hold Down Clamping:

- Inserta Clamps
- Sliding Channel Clamps
- Inserta Pliers
- Good Hand® Toggle Clamps

Stop, Position, & Locate Stock:

- Right Angle Brackets
- Straight Edge Stops
- Econo Stop & Clamping Squares
- Malleable Cast Iron Clamping Squares
- Heavy Duty Riser Blocks
- Stops, Rests, and V-Blocks

Clamps

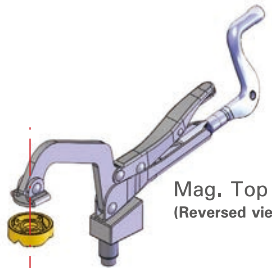

Inserta Pliers

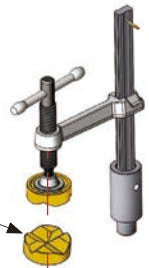

Inserta Clamps

Mag. Top V-Pads (Reversed view)

Quick hold-down clamping of flat, square, angled or round parts.

Locate / Stop

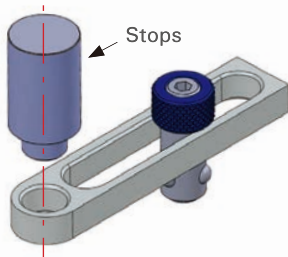

D-Stop Bars

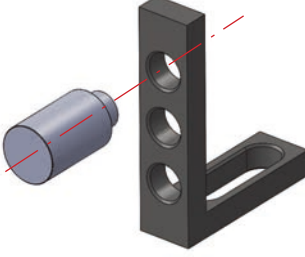

Right Angle Brackets

Stop, locate, and position parts.

Support Round Stock

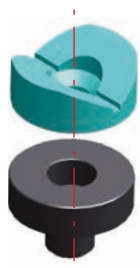

V-Block Spacers

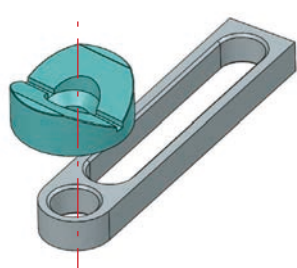

D-Stop Bars

Elevate and hold round parts.

Stop / Locate / Elevate

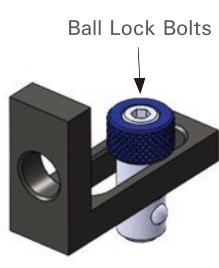

Ball Lock Bolts

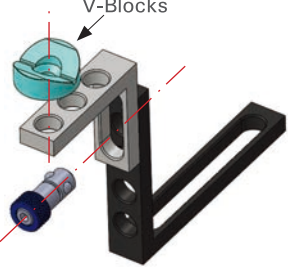

V-Blocks

Right Angle Brackets

Stop and locate parts.

Stack Right Angle Brackets to elevate and hold round parts.

CLAMPS

T-POST CLAMPS

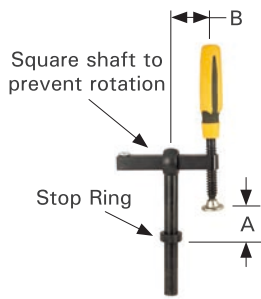

T61650



T51655

Place the Adjustable T-Post Clamp in any of the Ø16 mm holes on the BuildPro® Tabletop or Heavy Duty Riser Blocks for vertical hold down clamping.

Adjust the clamp arm along the vertical or horizontal axis for each unique hold down application. Adjustable arm provides precise clamping location by sliding the spindle to any desired pressure point.

Move the Stop Ring as needed to set the height of the clamp.

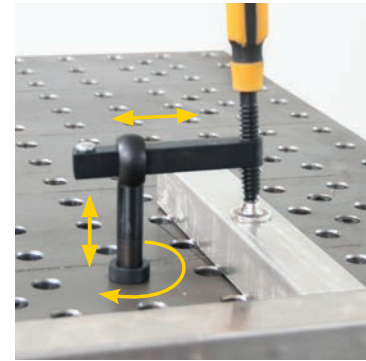

Part No.	Handle	Clamping Capacity A (mm)	Throat Depth B (mm)	Weight (kg)
T61650	Straight	Max. 114	44.5 - 82.5	0.6
T51655	T-Handle	Max. 114	44.5 - 82.5	0.6

Multi-Directional

PIVOTING T-POST CLAMP



Vertical Clamping

Angled Clamping

Horizontal Clamping



A magnetic top V-Pad (Part No. T64217) is INCLUDED for clamping round stock and square tubing edges.

Use the versatile Pivoting T-Post Clamp to apply angled clamping force. Clamp stock horizontally and vertically.

For **vertical** hold down clamping, or **angled** clamping, place the fixed Vertical Clamp arm, with Pivoting Spindle, in the clamp post.

For **horizontal** clamping, remove the fixed Vertical Clamp arm and Pivoting Spindle from the clamp post, and place directly into the tabletop holes.

Part No.	Clamping Capacity A (mm)	Throat Depth B (mm)	Weight (kg)
T61670	Max. 140	44.5 - 127	0.9





T-Handle
UDN6150 | UEN6200



Ratchet Handle
UERN6200

INSERTA CLAMPS

Place the Inserta Clamps into the 16 mm holes on the BuildPro® tabletop and squares for fast, easy clamping. Clamp in the vertical or horizontal position at any height.

The Ratchet Handle Model is ideal for tight space clamping, and the ratchet mechanism ensures rapid, vibration and torsion resistant clamping.

Clip the optional Top V-Pads (pg. 39) onto the top spindle to clamp round or angled stock. Remove the clamp arm by depressing the spring stop, and slide the Sidekick attachment (pg. 39) onto the clamp bar, followed by the clamp arm, for two point horizontal and vertical clamping force.

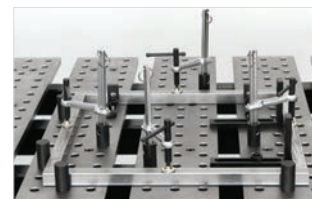

Part No.	Clamping Capacity (mm)	Throat Depth (mm)	Clamping Pressure (kg)	Rail Size (mm)	Weight (kg)
UDN6150	150	83	135	16 x 8	0.6
UEN6200	200	100	180	20 x 10	1.0
UERN6200	200	100	180	20 x 10	1.0

SLIDING CHANNEL CLAMPS *



The 360° Sliding Channel Clamp slides into the 40 mm spacing between plates which enables the clamp body to slide along the entire surface and swivel 360° for positioning at any point.

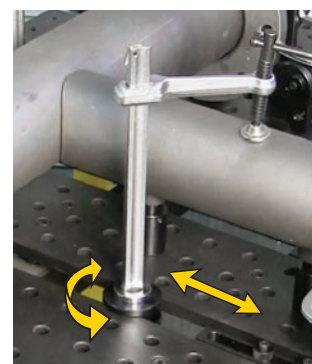

Part No.	Clamping Capacity (mm)	Throat Depth (mm)	Clamping Pressure (kg)	Rail Size (mm)	Weight (kg)
T61405	200	120	230	22 x 11	1.6
T61510	300	120	270	25.4 x 11.9	2.2
T61615	500	140	320	32 x 14	3.7

* Not applicable to slotless tables.

CLAMP ACCESSORIES

SIDEKICKS

Slide the Sidekick onto the clamp rail of Inserta Clamps and Sliding Channel Clamps for horizontal clamping force.



Part No.	For Inserta Clamps	For Sliding Channel Clamps	Stroke (mm)	Weight (kg)
XDSM	UDN6150	--	25	0.3
XFSM	--	T61405	35	0.6
XGSM	--	T61510	35	0.6
XMSM	--	T61615	35	0.6



V-PADS

Add the Magnetic Top V-Pad onto the swivel pad to hold round, square, flat, and angled stock.

Optional Clip-on Top V-pad clips onto the swivel pad for clamping round parts or 2 parts at once.



Alum. Magnetic Top V-Pad
T64217 | T64219



Clip-on Top V-Pads



Stainless Steel V-Pads
XDA2S | XFA2S

	Part No.	For Inserta Clamps	For T-Post Clamps	For Sliding Channel Clamps	Weight (kg)
Aluminum	T64217	UDN6150	T61650, T51655, T61670	--	0.02
	T64219	UEN6200	--	T61405 & T61510	0.02
Stainless Steel	XDA2	UDN6150	T61650, T51655, T61670	--	0.1
	XFA2	UEN6200	--	T61405 & T61510	0.2
	XMA2	--	--	T61615	0.3
	XDA2S	UDN6150	T61650, T51655, T61670	--	0.1
	XFA2S	UEN6200	--	T61405 & T61510	0.2



MAGNETIC PLUGS

Set of four 25 mm Magnetic Plug / Rest Button can be used on any flat surface, inserted into the holes on the BuildPro® Table or the holes on BuildPro® Economy Clamping Squares.



Part No.	Description	Weight (kg)
T65410-K4	4 pc. of Magnetic Plugs	0.1



Magnet keeps sheet metal in vertical position

INSERTA PLIERS

Insert into Ø16 mm for fast hold-down clamping.

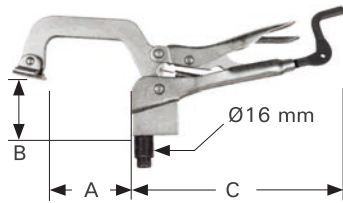

Mount on the Right Angle Bracket, Riser Block, or Clamping Squares for push down clamping at an elevated height for taller workpieces. The patented rear crank handle allows clamp pressure adjustment while the clamp is in locked position. Use the crank handle to pre-set the clamp opening in repetitious clamping applications.

** Can be used with Magnetic Top V-Pads. See pg. 37.*

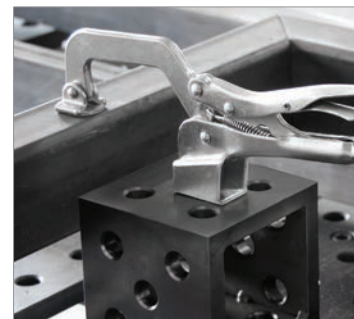

Part No.	Throat Depth A (mm)	Opening B (mm)	C (mm)	Weight (kg)
PT07K	50	60	150	0.3
PT09K	75	100	200	0.4
PT11K	85	100	265	0.7
PT14K	155	120	265	0.9

MOUNTING ADAPTER for the Inserta Pliers

It allows you to precisely place the tip of the Inserta Pliers anywhere on the table surface.

The Mounting Adapter swivels 360° and provides a 25 mm extension of the Inserta Pliers base for the extended reach, or retraction, of the Inserta Pliers as needed for precise placement of the clamping pad.

Simply replace the existing stud on the Inserta Pliers with the swivel Mounting Adapter.



Patent Pending

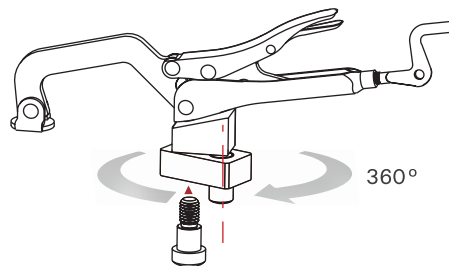

Part No.	Thread	Weight (kg)
T66010	M8	0.18

CLAMPS

SIDE CLAMP

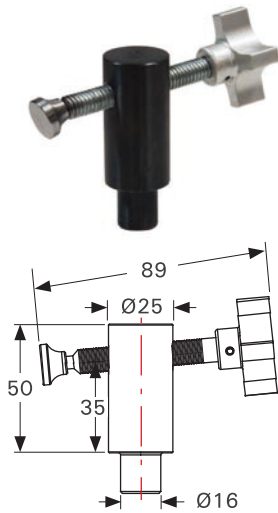

Insert into the Buildpro® table holes for low profile, light duty, horizontal clamping.

A turn of the aluminum knob advances the spindle, bringing the swivel foot to rest against the face of your stock or workpiece.



Part No.	Stroke (mm)	Weight (kg)
TCX6210	38	0.3

SIDE PUSH CLAMP XL

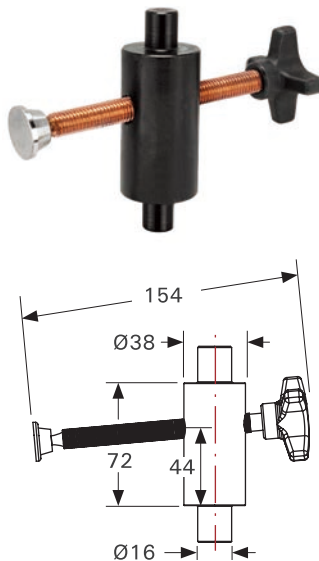

The side push clamp is designed for applying lateral pressure with a slight down force to keep the workpiece from lifting or rolling upwards.

Extra long spindle insures you can reach anywhere on the table. Copper plated spindle resists weld spatter.

A special flipping feature ensures that you can always get the pad placed at the right height, which is useful for smaller material sizes.

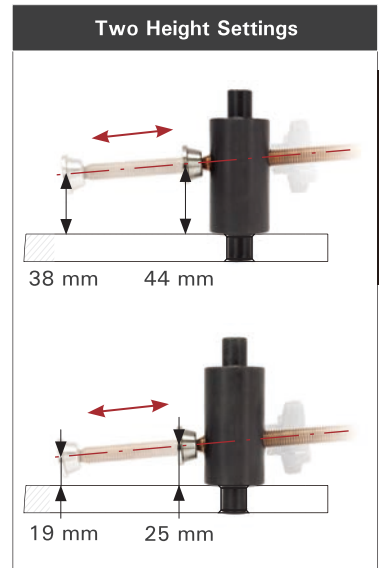

Part No.	Stroke (mm)	Weight (kg)
TCX6320	76	0.9

To change the height of the clamp:

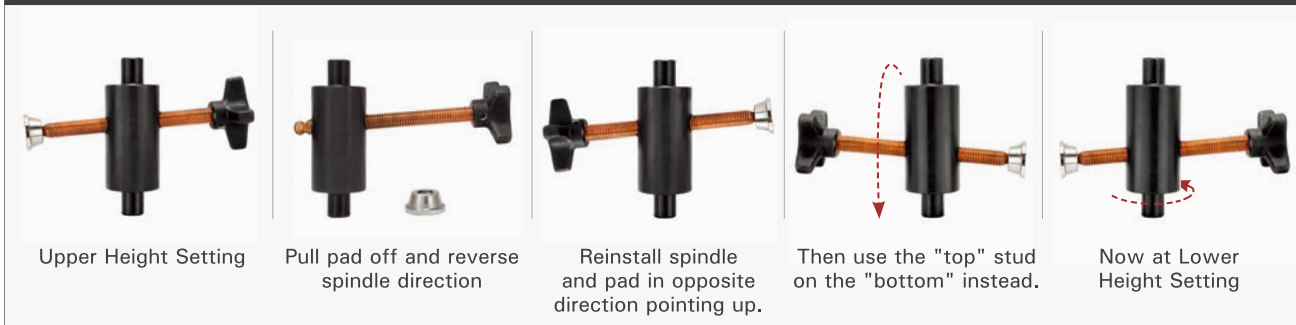

LOCKING CHAIN PLIERS

Clamp odd shaped multiple items. Hold two workpieces, or a group of materials securely in place while you weld. Adjust tension with crank handle.

- Replaceable chains in different lengths are available.
- Use with optional Table Mount Base Kit on your welding tables.



Easy-Remove Screw

Fishtail Chain End

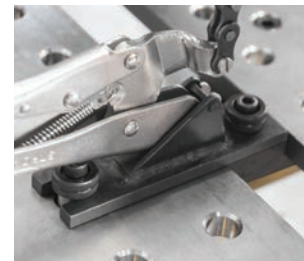

Part No.	Chain Length (mm)	Loop Dia. (mm)	Weight (kg)
PFC1024	600	up to 165	0.9
PFC1036	910	up to 270	1.1
PFC1048	1200	up to 360	1.4

CHAIN PLIERS MOUNTING BASE KIT

Table-mount chain hook and pliers mounts brackets, USED TOGETHER for table mount part hold down.

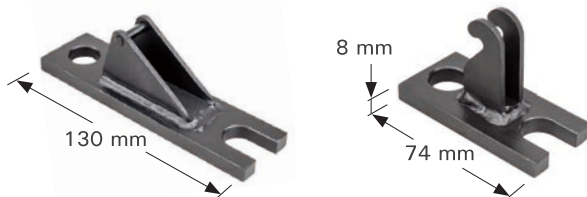

Part No.	Description	Weight (kg)
PXC90	Table Mount Base Kit (2 pc.)	0.5

REPLACEABLE CHAINS



Part No.	Description	Weight (kg)
PXC24	Replaceable chain 600 mm L	0.3
PXC36	Replaceable chain 910 mm L	0.4
PXC48	Replaceable chain 1,200 mm L	0.6

CLAMPS

TOGGLE CLAMPS & ADJUSTABLE MOUNTING BASE



Mount any of the seven Good Hand® Toggle Clamps listed below on this low-profile, pre-tapped Adjustable Mounting Base. Mount Toggle Clamps directly on the BuildPro® Tabletop, Riser Blocks or Econo Stop & Clamping Squares, for the height and reach required for each hold down application.

The thickness of the Aluminum base adds 16 mm to the maximum capacity of the Toggle Clamp.

Use Ball Lock Bolts (not included), to mount the Straight Edge Stop attachment.

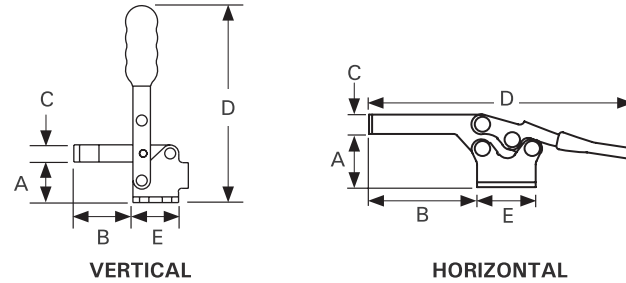

VERTICAL

HORIZONTAL

	Part No.	Mounting Hole (mm)	A (mm)	B (mm)	C (mm)	D (mm)	E (mm)	Weight (kg)
Vertical	GH-12050	4 x Ø5	22.6	33	9.6	95	25.4	0.2
	GH-12050-HB	4 x Ø5	42.2	33	9.6	122	25.4	0.2
	GH-12130	4 x Ø7	31.8	71	16	140	35.5	0.3
	GH-12130-HB	4 x Ø7	57.2	71	16	165	35.5	0.4
Horizontal	GH-12265	4 x Ø8	44.5	84	20	190	48.3	0.6
	GH-225-D	4 x Ø6	34.8	71	12.7	173	38.1	0.3
	GH-225-DHB	4 x Ø6	54.1	71	12.7	168	38.1	0.3

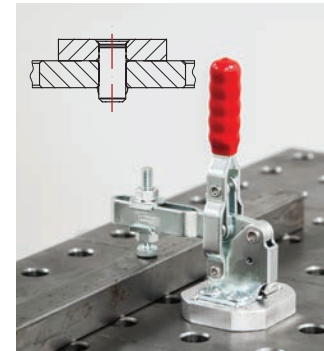

Directly mounted on the table using Flush Mount Ball Lock Bolt.



Mounted with Straight Edge Stop attachment and Ball Lock Bolts.

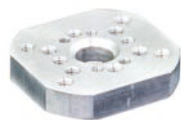
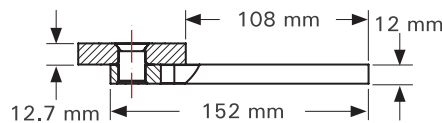
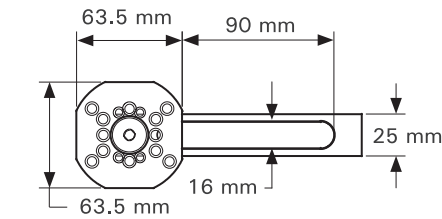
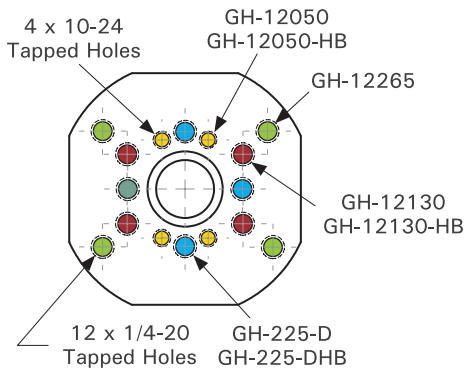
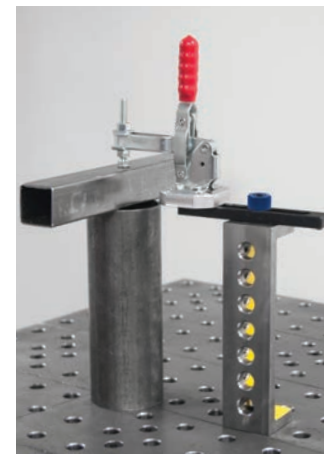

T50505GH-01



T60505GH

Part No.	Description	Weight (kg)
T50505GH-01	Pre-tapped Alum. Base ONLY.	0.2
T60505GH	Includes: pre-tapped Alum. Base + Straight Edge Stop + Flush Mount Screw.	0.3

BALL LOCK BOLTS

An essential time-saving fastener.

All Ball Lock Bolts are a time-saving and efficient method of locating and fastening fixture elements to the tabletop without having to reach underneath the table.

Insert the Ball Lock Bolt over the fixturing element and turn the knurled head with your hand for initial positioning.

The Ball Lock Bolt consists of three locking steel balls in the bolt shank that move outward to lock against the bottom chamfer of the table plate, pulling the fixture components securely downward and tightening them in place. Once all the Bolts are positioned, tighten the socket head cap screw top of the Bolts with a light turn of a hex wrench. Ball Lock Bolts release quickly from the Bolt top with a turn of your hex wrench.

UNIVERSAL BALL LOCK BOLT

The Universal Ball Lock Bolt features an adjustable sliding shoulder bushing, providing better surface contact while also reducing friction when torquing down screws.



Adjustable
T65055



Fixed Length
T65015



Fixed Length
T65010



Flush-Mount
T65020 | T65025

Part No.	Type	Description	Capacity (mm)	Weight (kg)	Use Hex Wrench	10-pc Bulk Package
T65010	Fixed	For connecting 2 accessories together	24	0.09	6 mm	T65011
T65015		For connecting an accessory to the tabletop	28	0.09		T65016
T65020	Flush	For connecting 2 accessories together	24	0.04	4 mm	T65021
T65025		For connecting an accessory to the tabletop	28	0.04		T65026
T65055	Adjustable	Connecting tables to accessories, and accessories to accessories.	22 ~ 27	0.04	6 mm	T65056

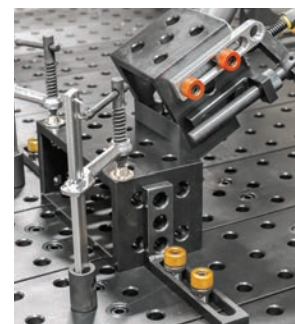
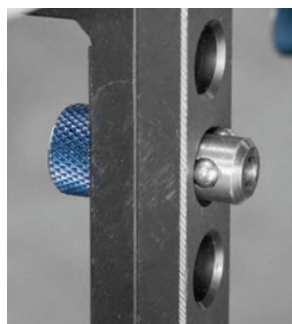
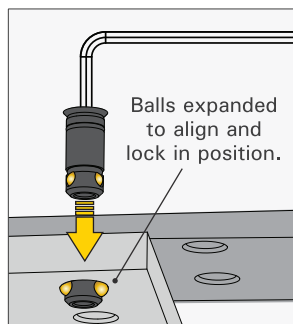

BALL LOCK BOLT REPLACEMENT

4 Steel Balls and 6 O-Rings



Part No.	Weight (kg)
TMS5101	0.01

RECEIVER BUSHING

Use the Receiver Bushing with Ball Lock Bolts [Adjustable models and T65015] when mounting two fixturing elements together slot-to-slot.



Part No.	Weight (kg)
T65804	0.01

LOCATING PIN



T64201

Locating Pins provide an economic alternative to using multiple Ball Lock Bolts.

Use Locating Pins in combination with Ball Lock Bolts to fasten fixturing elements, such as Straight Edge Stops, to the BuildPro Tabletop. Locating Pins aid in holding fixturing elements in position.

(A minimum of one Ball Lock Bolt must be used along with the Locating Pin to secure accessories to the tabletop. The Locating Pin cannot be used as an independent fastening element.)



Part No.	Weight (kg)
T64201	0.07

CONNECTING BOLTS

These precision shoulder screws fit into the table holes and can hold and position BuildPro[®] accessories and other components.

Choose from standard and flush-mounted versions. Model T65560 is for connecting 2 accessories together. The model of 10-pc bulk package is T65561.



Standard
Hex Wrench: 8 mm



Flush-Mounted
Hex Wrench: 6 mm



(A nut and a washer included.)



T65560
Hex Wrench: 6 mm

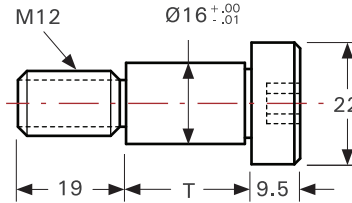

Standard

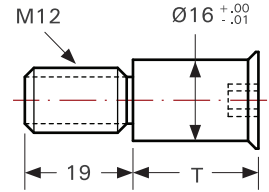

Flush-Mounted

Part No.	Type	T (mm)	Weight (kg)
T931605	Standard	12	0.05
T931607		20	0.07
T931608		22	0.07
T931610		25	0.08
T931612		32	0.10
T932607	Flush	20	0.04
T932608		22	0.05
T932610		25	0.05
T932612		32	0.08

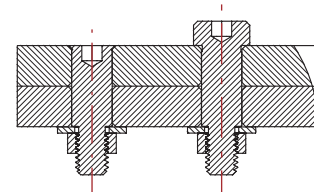

Part No.	Type	Capacity (mm)	Weight (kg)
T65560	Flush	28	0.02

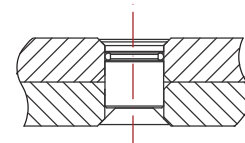

For 2 Threaded Holes with one magnet

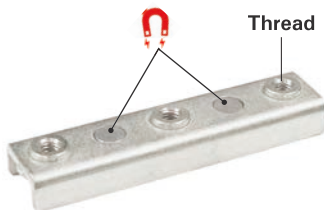

For 3 Threaded Holes with two magnets

THREADED ADAPTERS

Convert any hole in the table into a threaded hole. Place the Adapter in position beneath the tabletop, in alignment with table holes. Magnets hold threaded adapter in place.

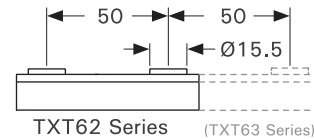

TXT62 Series (TXT63 Series)

Part No.	Number of Holes	Threaded Holes	Number of Magnets	Weight (kg)
TXT6203	2	M8	1	0.13
TXT6204		M10		0.13
TXT6205		M12		0.13
TXT6303	3	M8	2	0.26
TXT6304		M10		0.26
TXT6305		M12		0.26

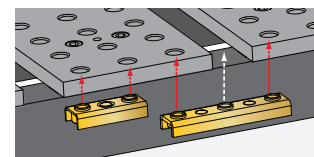

STOPS

ECCENTRIC PADS

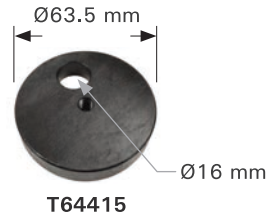
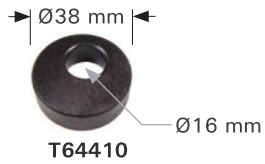

Using the "CAM" design principle, the eccentric pad provides a quick way to position the edge of the workpiece to a locating stop. The 360° rotation allows infinite adjustments.

Ideal for locating round and odd shape parts where conventional edge stops cannot reach.

* Eccentric Pads are 12.7 mm thick.

[Use Ball Lock Bolts, *pg. 44* not included, to mount the Eccentric Pads]

Part No.	Adjust Range (mm)	Offset (mm)	Thread	Weight (kg)
T54410	14 - 24	5	--	0.1
T54415	15 - 50	17.5	M8	0.2

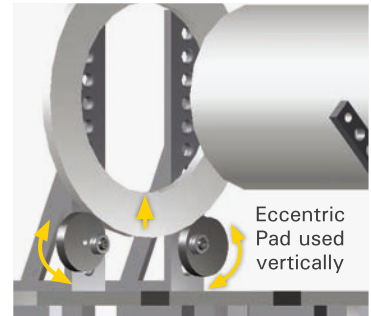
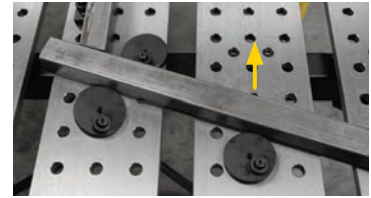

D-STOP BAR



The Aluminum D-Stop Bars are lightweight and easy to maneuver. It can be locked into position with Ball Lock Bolts (*pg. 44*), or Socket Head Shoulder Screws (*pg. 46*).

11.5 mm thicknesses for use as spacers.

Part No.	Dimension (mm)	Slot Length (mm)	Weight (kg)
T60630	121 x 25 x 11.5	76.2	0.04

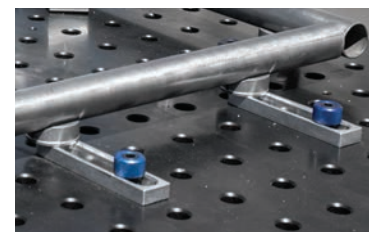
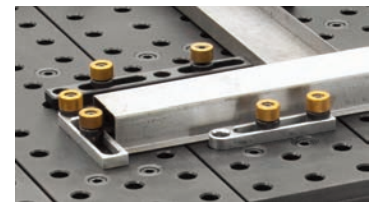

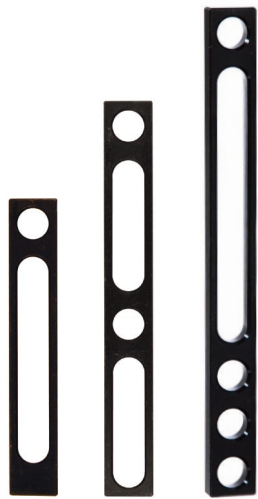

T60505 T60510 T60517

STRAIGHT EDGE STOPS

Long slots make these precision machined Straight Edge Stops infinitely adjustable in fixturing applications and squaring up parts.

Use with V-Blocks (*see pg. 54*) for the adjustable fixturing of round tubes.

Part No.	Dimension (mm)	Ø16 Holes	Slot Length (mm)	Weight (kg)
T60505	150 x 30 x 12	1	90	0.2
T60510	200 x 30 x 12	2	2 x 51	0.3
T60517	250 x 30 x 12	4	125	0.4

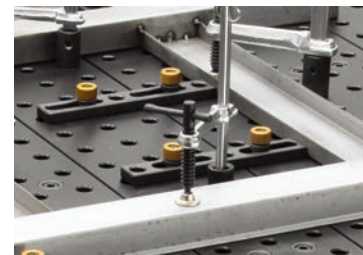

STOPS

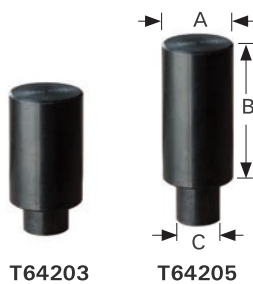

T64203

T64205

T64203 and T64205 are used as a stop wherever parts need to be positively located for clamping.

Part No.	Ø A (mm)	B (mm)	Ø C (mm)	Weight (kg)
T64203	25	38	16	0.15
T64205	25	50	16	0.22

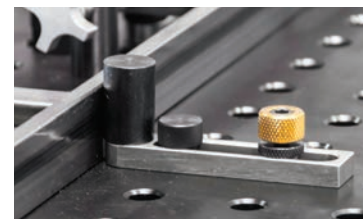
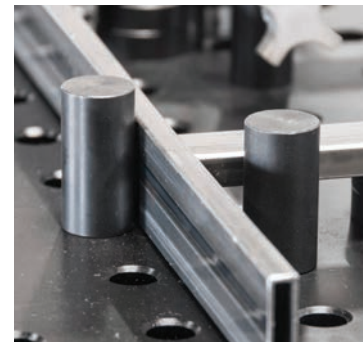

CLAMPING SQUARES

RIGHT ANGLE BRACKETS

These precision machined angle squares hold material at 90°. The holes and slots combination allow for infinite adjustments in fixturing. For heavy duty applications, see the Riser Blocks on *pg. 50*.

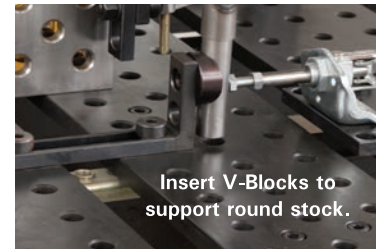

Insert V-Blocks to support round stock.



Part No.	Dimension (mm)	Plate Thickness (mm)	Holes	Slot Length (mm)	Weight (kg)
T60304	41 x 91 x 30	12	1	51	0.2
T60305	91 x 91 x 30		3	51	0.3
T60310	90 x 150 x 30		3	105	0.4
T60320	193 x 150 x 30		7	105	0.6
T60330	300 x 150 x 50		11	105	2.0

ECONO STOP & CLAMPING SQUARES

Economy Stop and Clamping Squares feature three surfaces for use in a wide variety of fit up applications.

Place Inserta Pliers or Inserta Clamps into any of the CNC machined holes for horizontal or vertical clamping at any height. Stack the Clamping Squares to brace tall workpieces. Use the top holes for mounting the Squares in a fixed location. The lower base is slotted for adjustable mounting.

Top and bottom plates are 12 mm thick and front sides are 3 mm thick.



Part No.	Dimension (mm)	Weight (kg)
T60205	50 x 138 x 100	1.2
T60210	50 x 138 x 200	1.7
T60215	50 x 138 x 300	2.1



T60231 T60230



T60251 T60250

MALLEABLE IRON CLAMPING SQUARES

Versatile four-sided Clamping Squares. CNC machined faces.

T60231 & T60230 have 26 Holes, 2 Slots on each.

T60251 & T60250 have 43 Holes, 7 Slots on each.

Part No.	Description	Dimension (mm)	Weight (kg)
T60231	Left Angle	50 x 140 x 300	2.9
T60230	Right Angle	50 x 140 x 300	2.9
T60251	Left Angle	50 x 195 x 500	6.7
T60250	Right Angle	50 x 195 x 500	6.7

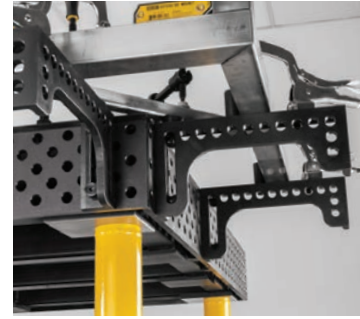

T60120



T60115



T60125



T60140



T60130



T60135



T60145

HEAVY DUTY RISER BLOCKS

Slotted end for adjustable mounting.

These nitrided five-face precision machined Riser Blocks feature accurate bored holes in a diagonal pattern.

Use Riser Blocks individually, or stacked, to elevate a workpiece or clamp. Cross join the Blocks for use as a beam. Use the Blocks to mount a BuildPro[®] plate to the side or end of the table, or to join tables together.

Models T60120, T60125, T60130 and so on feature two slots at one end for adjustable positioning.

Part No.	Machined Surfaces	Dimension (mm)	Weight (kg)
T60115	4 faces	50 x 50 x 250	2.0
T60120	5 faces	100 x 100 x 100	3.4
T60125		100 x 100 x 200	5.7
T60130		100 x 100 x 300	7.8
T60135		100 x 100 x 500	12.6
T60140		200 x 100 x 500	16.8
T60145		200 x 100 x 1,000	34.4

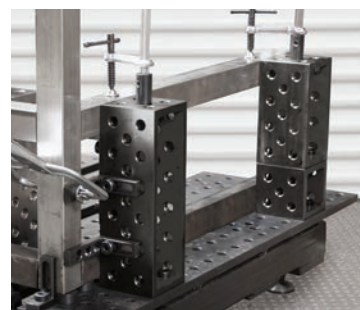
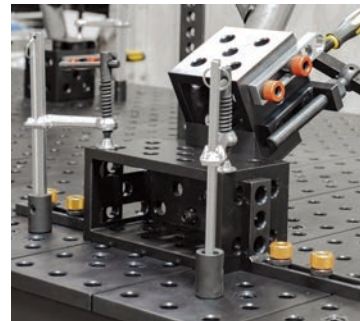

ACCESSORIES



T61825

unit: mm

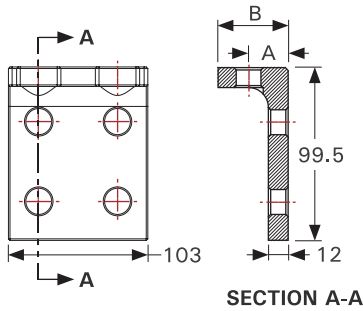

SIDE BRACKETS

Locate or clamp your weldment at or beyond the table edge, by mounting the Side Bracket at the edge of your slotted and MAX Tabletop.

Use the Side Bracket to vertically mount clamping elements, such as the Straight Edge Stops or Right Angle Brackets to add greater functionality to your table in fixturing oversized weldments.

Part No.	A (mm)	B (mm)	Mounting Location	Weight (kg)
T61825	25	36	MAX Tables - END or SIDE Slotted Tables - END Rhino Cart - ANY SIDE	1.1
T61830	29.2	41.5	Slotted Tables - SIDE	1.2

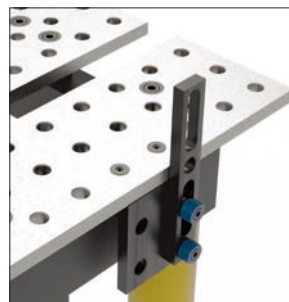
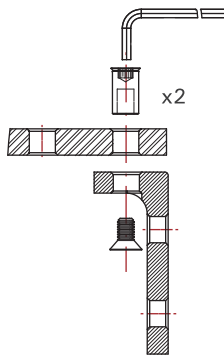

Slotted table shown



MAX table shown

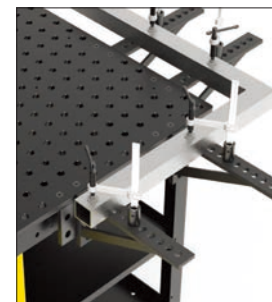

T61825 on any side of Rhino Cart

FIXTURING PLATES

The versatile plate can be used as a fixturing element, or as a link to connect two tables together.



T61006



T61009



T62005-01

Part No.	Finish	Description	Thickness (mm)	Weight (kg)
T61006	Standard	100 x 160 mm Fixturing Plate, 6 holes	16	1.9
T61009	Standard	150 x 160 mm Fixturing Plate, 9 holes	16	2.8
T62005-01	Nitrided	500 x 160 mm Fixturing Plate	16	9.0



ADJUSTABLE & FIXED RESTS

Developed by customer demand, the Adjustable Rests are operated manually, by hand adjustment, with a turn of the easy-grip knurled band for complete control in precise, minute height adjustment. (PN T64213: Range: 50 ~ 70 mm. PN T64212: 22 mm height with 8 mm stroke range.)

Insert into any fixturing hole on the BuildPro® Modular Welding Table for use as a support or rest for aligning stock at a uniform height and providing welding clearance.

The rests feature 16 mm bored hole on top to hold V-Blocks and V-Block Spacers. They fit into the top cavity of the rests to support round pipes. Rests are stackable for use with tall stock.

Both T64213 and T6214 have two interchangeable Locating Posts.

Three mounting options:

- Insert into any hole on the BuildPro table with the Ø16 mm Locating Post.
- Securely fasten to the tabletop for repetitive applications using the Locking Pin with cap screw (included).
- Remove the Locating Post or the Locking Pin, and place the Rest anywhere on the BuildPro tabletop.



After setting at the desired height, tighten set screw to LOCK.

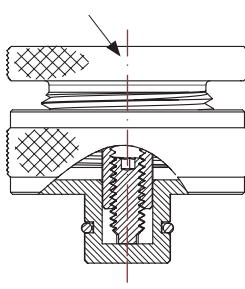

Part No.	Top Dia. (mm)	Locating Post Dia. (mm)	Height (mm)	Weight (kg)
T64213	44.5	16	50 ~ 70	0.5
T64212	44.5	16	22 ~ 30	0.3
T64214	38	16	50	0.3

RESTS



T50737



T51740



T61745

MAGNETIC REST BUTTONS

Magnets on the bottom of the Magnetic Rest Buttons allow the button to be used at ANY point on the tabletop to elevate workpieces.

Stack Magnetic Rest Buttons to elevate workpieces in 11.5 mm, 16 mm, and 25 mm increments.

Part No.	Dimension Ø x H (mm)	Weight (kg)
T50737	40 x 11.5	0.09
T51740	40 x 16	0.14
T61745	40 x 25	0.18

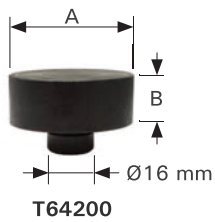

T64200

REST BUTTONS

The rest button serves as a part rest to elevate parts above the table top.

Part No.	Ø A (mm)	B (mm)	Weight (kg)
T64200	40	16	0.2

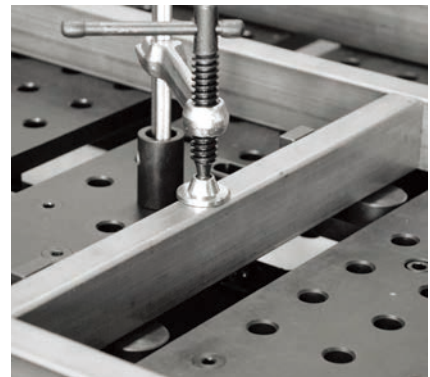

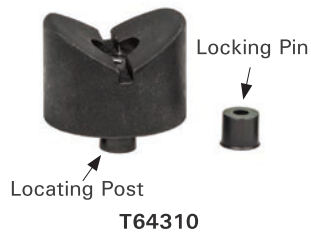

HEAVY DUTY V-BLOCKS

Developed by customer demand, these Heavy Duty V-Blocks hold round stock from 76 – 203 mm in diameter at 120° - 150°.

Part No.	Angle	Dimension (mm)	Max. Tube Size (mm)	Weight (kg)
T64310	120°	Ø61 x 43	76	0.6
T64315	150°	Ø81 x 35.5	203	0.7

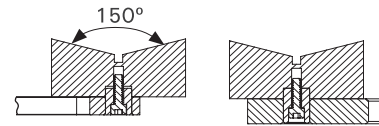
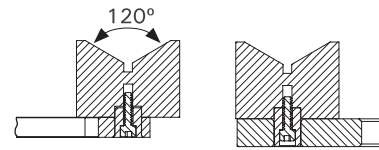

V-BLOCKS

V-Blocks are designed to hold round parts. They fit into the holes of the: BuildPro[®] Table, Riser Blocks and Right Angle Brackets.

Part No.	Angle	Dimension (mm)	Max. Tube Size (mm)	Weight (kg)
T64210	90°	Ø40 x 31	50	0.15
T64215	120°	Ø40 x 26	65	0.12
T64216	120°	Ø40 x 22.6	65	0.02

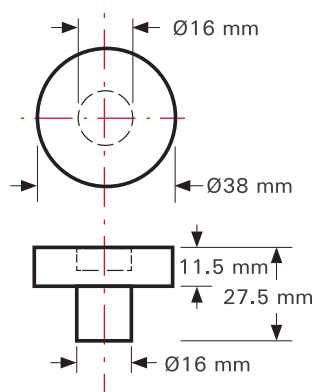

V-BLOCK SPACER

Use the V-Block Spacer T64211 to elevate V-Blocks 11.5 mm for height uniformity when fixturing with the Straight Edge Stops.



Part No.	Weight (kg)
T64211	0.1



RESTS

BEND RESTS



The Bend Rest supports round stock at bends and elbows in fixturing, preventing lateral movement and providing clamp support.

The low profile design allows use of multiple Bend Rests as needed to elevate stock, leaving ample space for clamping.

Place Bend Rests directly into any hole on the BuildPro® Tabletop, or use in combination with BuildPro® Rests to set at desired height to meet clearance or alignment requirements for each unique fixture.

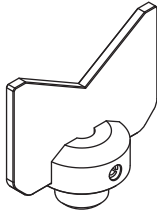
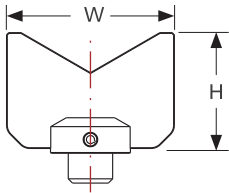

Part No.	Angle	W x H (mm)	Max. Tube Size (mm)	Weight (kg)
T54320	120°	60 x 32.2	63.5	0.2
T54325	120°	60 x 43	76	0.2
T54330	150°	80 x 35	203	0.2

SETUP CONE

Use the Setup Cone to locate and position round tubing horizontally or vertically through the centerline. The Setup Cone locates from within the tube ID [max. 41 mm] at the tube ends, allowing for centerline location and positioning. Mount the Setup Cones on BuildPro® Accessories using either of two interchangeable bases provided:

Horizontal clamping: Securely fasten to any 16 mm mounting hole on clamping accessories using the Locking Pin with cap screw.

Vertical clamping: Insert into any 16 mm mounting hole on clamping accessories or the tabletop, using the Locating Post.

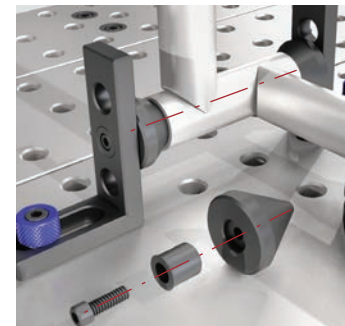
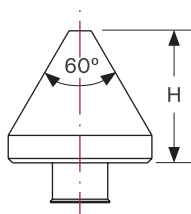

Horizontal application using Locking Pin

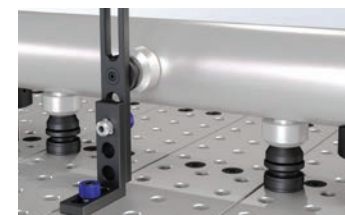

Vertical application using Locating Post + V-Block Spacer

Part No.	Angle	Dia. x H (mm)	ID Pipe Range (mm)	Weight (kg)
T64220	60°	41 x 38	6 < x < 41	0.2

SLOT FILLER KIT *

Use the Channel Block and Rest Button when a flat, continuous support surface is required directly over the 40 mm table slots.

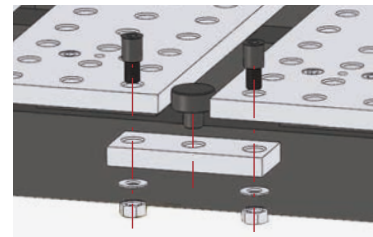
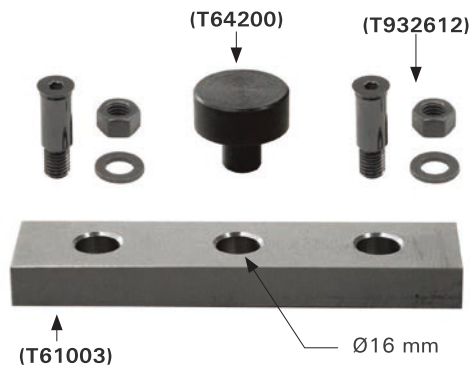

Mount the Channel Block and insert the Rest Button to create a continuous work surface over the table slot.

Part No.	Includes	Weight (kg)
T60930	1 pc. Channel Block (T61003) 160 x 40 x 16 mm 1 pc. Rest Button (T64200) 2 pc. Flush-mounted Screws (T932612)	1.1

* Not applicable to BuildPro[®] MAX tables.

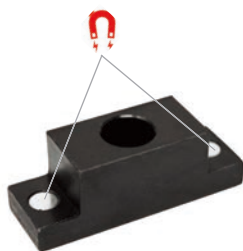

T60910
One Ø16 mm hole



T60920
Two Ø16 mm holes

T-SLOT ADAPTERS *

Slide the T-Slot Adapter into any table slot to create a Ø16 mm table hole along the table slots as needed in fixturing. (Tapped hole is consistent with table hole depth and diameter.)

Locate and mount any fixturing element [Right Angle Brackets, Riser Blocks, Econo Stop & Clamping Squares] directly over table slots.

Part No.	Weight (kg)
T60910	0.2
T60920	0.6

* Not applicable to BuildPro[®] MAX tables.



SLIDING CHANNEL BASES *

Mount work-holding devices onto these Sliding Channel Bases. Slide into the 40 mm slots between the plates.



T61300



T61305

Part No.	Description	Weight (kg)
T61300	Non-rotatable and without holes for user customization.	0.7
T61305	Rotatable with M12 threaded hole on one side, M10 on the other side.	0.6

* Not applicable to BuildPro[®] MAX tables.

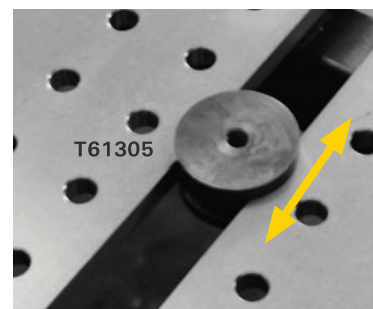

UNIVERSAL FLANGE CLAMPING PLATE

Hold ASME / ANSI / DIN Standard Flanges in position for flange + pipe joining!

Reduce set-up time and increase weld quality for greater repeatability.

Hold, accurately locate, and securely clamp down standard flanges. Guide Blocks in the Flange Clamping Plate expand or contract symmetrically to accurately locate the flange for greater weld quality. The patented Flange Clamping Plate provides full welding clearance, and allows easy removal of the finished weldment.

Fits standard flanges with these specifications:

- Hole circle diameter range: 76.2 mm ~ 465 mm
- Number of bolt holes: 4, 8, 12, 16

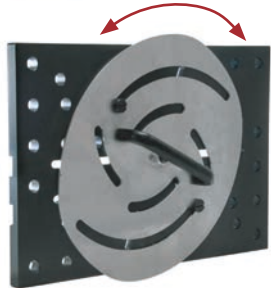

Inserta Pliers



Locating Pins

Part No.	Kit Includes	Dimension (mm)	Weight (kg)
T60430	1 pc. Universal Flange & Pipe Clamping Plate w/ 8 Locating Pins: 2 of each size - 26 mm, 22 mm, 18 mm, 14 mm; 2 pc. Part No. PT09K Inserta Pliers.	455 x 305 x 16	19.4

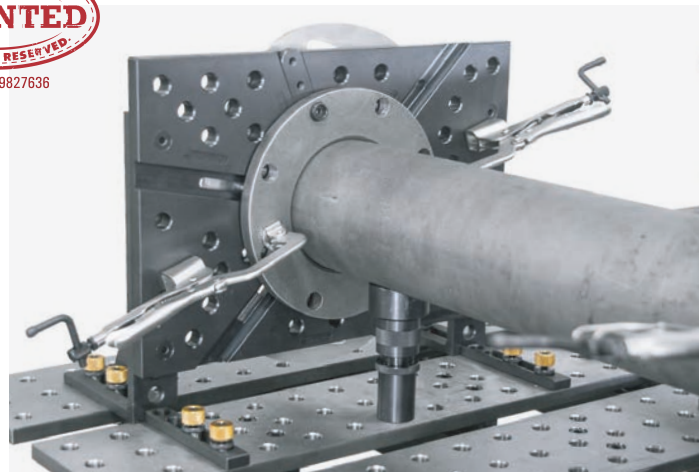

The fixture is strong and rigid, to withstand cumulative stresses resulting from welding, and holds the joined flange & pipe during cool down to prevent distortion, expansion, and contraction.

Load the flange & pipe, accurately position, and unload quickly for quality welds, maximum productivity, and repeatability.

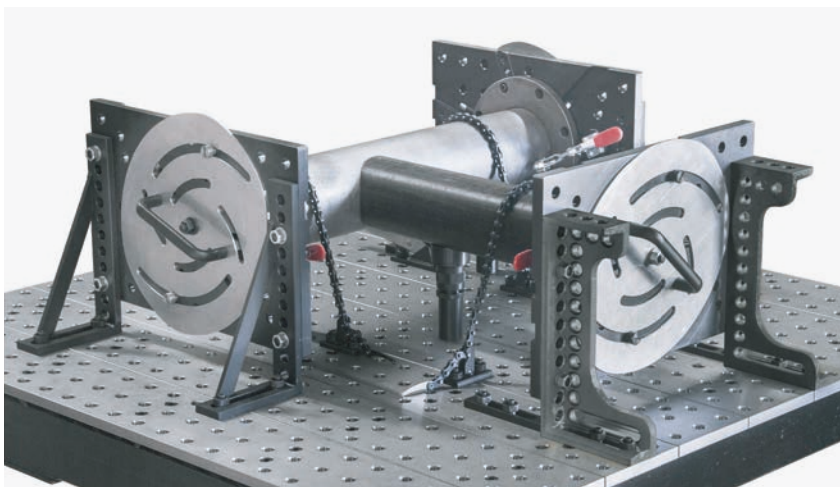

Use multiple Universal Flange & Pipe Fixtures to setup pipes for a T-Joint.

Find the fixturing video on:
youtu.be/dvw1Xj1KfHc



NOTCHER

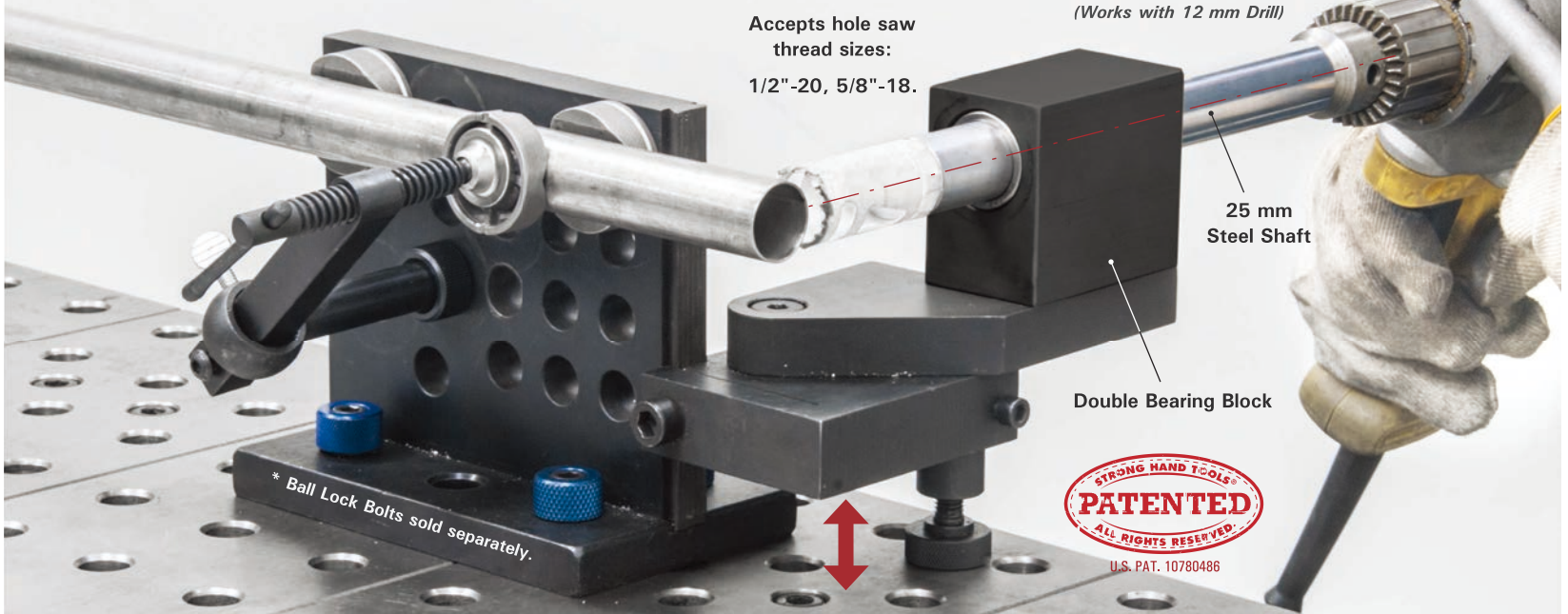

BuildPro® Tube & Pipe Notcher
(1 pc.)



Aluminum V-Blocks
(2 pcs.)



Clamp with Magnetic V-Pad
(1 pc.)

Notch tubes and pipes at the accurate angle and length.

Mounting your Notcher on the BuildPro® welding tables, Fixturing Plates or mobile working stations allows for quick and accurate setups when notching multiple parts.

Notch 25 ~ 63.5 mm OD pipes or square tubes at any angle, or off-center. Position the two V-Blocks and clamp as needed.

Part No.	Kit Includes	Weight (kg)
ATN100M	1 pc. BuildPro® Tube & Pipe Notcher 2 pcs. Aluminum V-Blocks for tube locating 1 pc. Clamp with Magnetic V-Pad	9

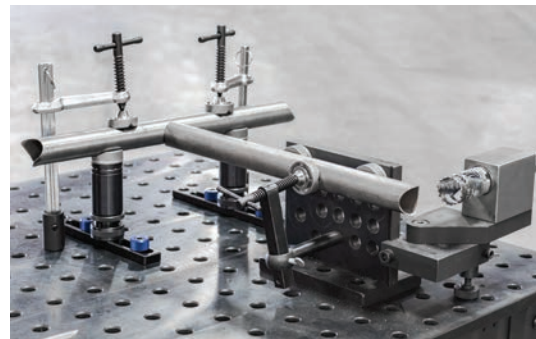
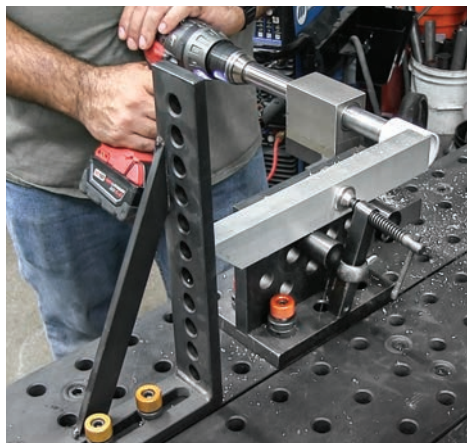

Arrange the Clamp and Aluminum V-Blocks on the Modular Fixturing Block as needed for proper part positioning in each notching application.



Height Setting Scale

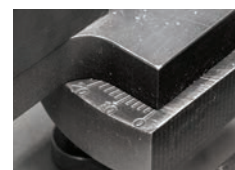

Angle Setting Scale

NOTCHER

In the examples below, the BuildPro® Tube & Pipe Notcher is used to notch workpieces as needed to fit seamlessly into a final assembly:

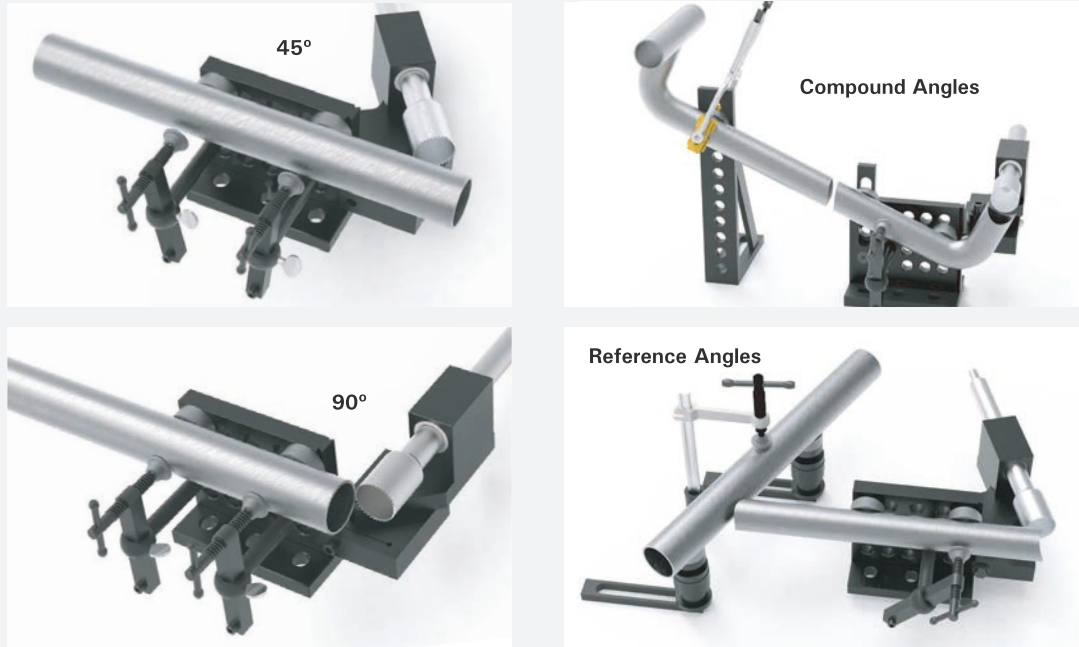

ADDITIONAL ACCESSORIES FOR NOTCHER:



NOTCHER ADAPTER

The Adapter is compatible with:
Annular cutter with 19 mm shank.
** Annular cutter not included.*

Part No.	Weight (kg)
ATNA20	0.09



CLAMP KIT FOR NOTCHER

T-Post Clamp (PN T51655) with
Magnetic V-Pad (PN T64217) for use
with notcher.

Part No.	Weight (kg)
ATNC60	0.68



ALUMINUM V-BLOCKS

Aluminum V-Blocks for tube
positioning. *See pg. 54 for details.*

Part No.	Weight (kg)
T64216	0.02

TABLE GROUNDING ADAPTOR

This grounding clamp offers an excellent solution for grounding to 16 mm fixturing tables for welding applications. The connectors are designed to easily twist-lock on and off while delivering consistent ground. The clamp is designed to fit into any standard 16 mm diameter hole of 12 mm depth or greater.

Grounding capacity will vary based on the cable used, but is designed to fit up to 3/0 size cables.



Part No.	Dimension (mm)	Weight (kg)
T54700	150 x 39	0.18

TOOL CART

"Fully Open" design for visibility and quick access.

The BuildPro[®] Tool Cart will help you inventory and organize your BuildPro Clamps and Components, and keep them within arm's reach



for faster fixture setup, and tear down.

Dedicated placement for each clamp and component makes the cart easy to setup and maintain. Smart design features allow for quick, convenient "park and pickup" of the Clamps and Components.

The Cart is constructed from 50 x 25 mm tubing with a rust resistant powder coated black finish. Two fixed casters and two swiveling casters with foot pedal safety lock provide easy maneuverability.



Use the Cart to hold any of the BuildPro Fixturing Kits. (Kits sold separately.)

Part No.	Dimension W x D x H (mm)	Capacity (kg)	Gross Weight (kg)
TMC8080	800 x 500 x 1,100	100	36

PORTABLE FIXTUREPOINT WELDING TABLE

Portable, positionable welding table for TIG welding of small parts.

Rigid construction, multi-angle settings. Easily moves around the shop!

Create your setup in the horizontal position, then set the ideal tabletop angle for worker comfort in each unique project! Parts stay securely clamped in position at any angle.

Tabletop Size:	600 x 450 mm
Top Plate Thickness:	4 mm
Hole Diameter:	16 mm
Grid Pattern:	50 x 50 mm
Loading Capacity:	27 kg

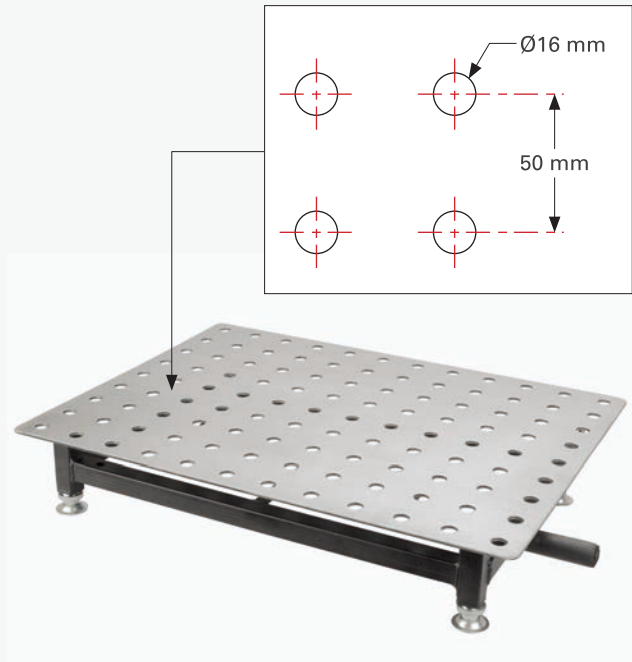

Adjust tabletop angle for worker comfort in each unique project!



Rigid construction, multi-angle settings: 30°, 45°, and 65°.



Leveling Pad adjust from 0 ~ 40 mm

Check our website:
buildprotables.com
 for Portable
 FixturePoint table
 w/ 12-pc Clamping
 kit "TA66045-K1".
 See pg. 70 for kit
 details.

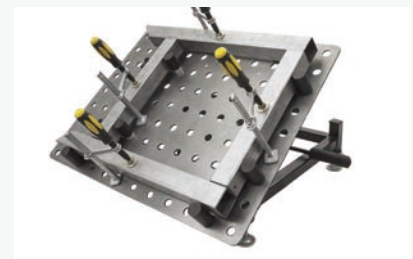

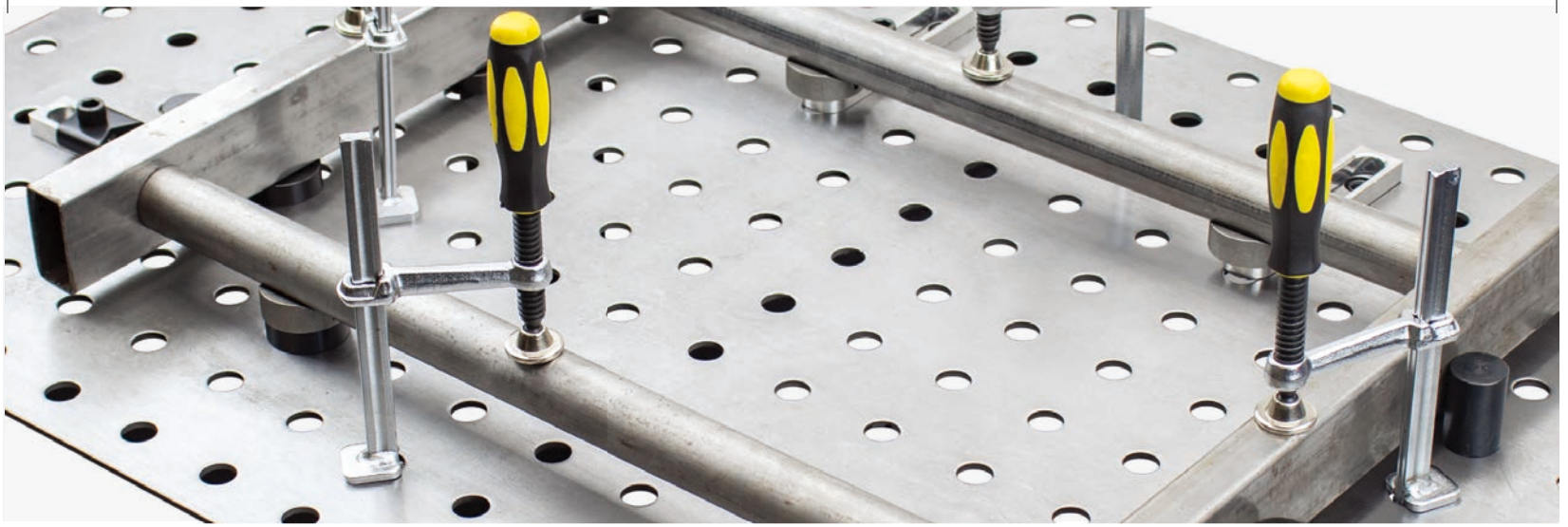

FIXTUREPOINT JIG & FIXTURE TABLE

A Light Weight, Compact Modular Fixturing System.

The economy priced FixturePoint Table is ideal for the setup of 2D frames and other basic fixtures.

Choose from two fixturing kits that mate to the 16 mm holes on the 900 x 600 x 4 mm tabletop.

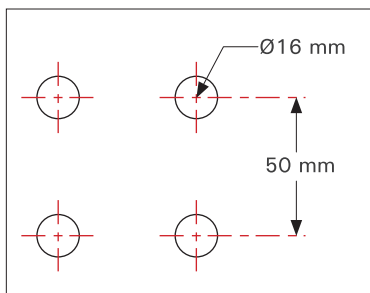

The FixturePoint™ tabletop can be detached from the leg frame for placement on alternate work surfaces as needed.

Check our website: www.buildprotables.com for more details about FixturePoint system.





MODULAR FIXTURING KITS

TABLES & ACCESSORIES

MOBILE WORKING STATIONS

PLATFORMS

FIXTURE ELEMENTS

SPECIAL TOOLS

KITS

PART NO. TMK635

128-pc. BuildPro Square Tube Fixturing Kit | Gross Weight: 74 kg

BASIC FRAMING KIT



T61003	T65015	T65025	T64415	T60210	T60215
2x	20x	4x	2x	12x	8x



T64200	MST327	PR115S	TXT6205	UND6150	UEN6200
2x	4x	12x	4x	6x	4x



PT11K	T60304	T60305	T931605	T931608
4x	10x	2x	24x	8x

PART NO. TMK637

166-pc. BuildPro Round Tube Fixturing Kit | Gross Weight: 61 kg



T61003	T60505	T60510	PG637V	T60210	T60215
2x	8x	4x	16x	8x	8x



UDN6150	XDA2	T64215	T64211	T65015	T60310
8x	8x	24x	8x	20x	12x



T60320	T931605	T931608
4x	16x	20x

MODULAR FIXTURING KITS

PART NO. TMK610

38-pc. BuildPro Fixturing Kit | Gross Weight: 9 kg



T65010	T65015	T50737	UDN6150	T64205	T60305
4x	8x	4x	4x	4x	2x



TXT6204	TXT6205	T60505	T60510
1x	1x	6x	4x

PART NO. TMK620

80-pc. BuildPro Fixturing Kit | Gross Weight: 21 kg



T65010	T65015	T65055	T64210	T64215	T64205
10x	10x	4x	2x	2x	4x



UDN6150	UEN6200	UERN6200	TXT6204	TXT6205	XDA2
4x	2x	2x	2x	2x	2x



XFA2	T64410	T64415	T60304	T60305	T60310
2x	2x	2x	4x	4x	4x



T50737	T60505	T60510	T60517
4x	4x	4x	4x

PART NO. TMK630

120-pc. BuildPro Fixturing Kit | Gross Weight: 40 kg

MOST POPULAR KIT



T65010	T65015	T65055	T50737	T64205	T60505
10x	20x	10x	4x	4x	4x



T60510	T60517	T64210	T64215	UND6150	UEN6200
4x	4x	4x	4x	4x	4x



UERN6200	T60205	T60210	T60304	T60305	T60310
2x	2x	2x	4x	4x	4x



T60320	T60330	T64410	T64415	PT09K	PT11K
2x	2x	2x	2x	2x	2x



UDV45M	TXT6204	TXT6205	XDA2	XFA2	XDV4
2x	2x	2x	2x	2x	2x















XFV4
2x







MODULAR FIXTURING KITS

PART NO. TMK640

146-pc. BuildPro Fixturing Kit | Gross Weight: 71 kg







					
T65010	T65015	T65055	T64410	T64415	T50737
10x	20x	10x	2x	2x	4x

					
T54605	T60120	T60125	T60505	T60510	T60517
2x	2x	2x	4x	4x	4x

					
PT14K	UDV45M	PG634V	TXT6204	TXT6205	T65410
2x	2x	2x	4x	4x	2x

					
T64210	T64215	XDA2	XFA2	XDV4	XFV4
4x	4x	4x	4x	2x	2x

					
UDN6150	UEN6200	UERN6200	T64205	T60304	T60305
8x	8x	2x	4x	4x	4x

					
T60310	T60320	T60330	T60205	T60210	T60215
4x	2x	2x	2x	2x	2x

TABLES & ACCESSORIES

MOBILE WORKING STATIONS

PLATFORMS

FIXTURE ELEMENTS

SPECIAL TOOLS

KITS

PART NO. TMK650

172-pc. BuildPro Fixturing Kit | Gross Weight: 102 kg

					
T65010	T65015	T65055	TXT6204	TXT6205	T64205
20x	20x	10x	4x	4x	4x
					
T64210	T64215	XDV4	XFV4	T60505	T60510
4x	4x	2x	2x	4x	4x
					
T60517	UDV45M	UDV65M	T64410	T64415	T54605
4x	2x	2x	2x	2x	2x
					
T65410	T50737	UDN6150	UEN6200	UERN6200	T60205
4x	4x	8x	8x	4x	2x
					
T60210	T60215	T60304	T60305	T60310	T60320
2x	4x	4x	4x	4x	2x
					
T60330	PT11K	PT14K	PG637V	XDA2	XFA2
2x	4x	4x	2x	4x	4x
					
T60120	T60125	T60130			
2x	2x	2x			

OTHER OPTIONAL EXTRA FIXTURING KITS

PART NO. TMK605

10-pc. BuildPro Fixturing Kit | Gross Weight: 5 kg

TABLE JOINING KIT



T60115	T932610
2x	8x

PART NO. TMK600-10

6-pc. Optional Extra Fixturing Kit | Gross Weight: 4 kg



T61670	PT11K	T66010
2x	2x	2x

PART NO. TMK600-20

4-pc. Optional Extra Fixturing Kit | Gross Weight: 22 kg



T60231	T60230	T60130
1x	1x	2x

PART NO. TMK600-30

6-pc. Optional Extra Fixturing Kit | Gross Weight: 6 kg



T60310	T60320	T60330
2x	2x	2x

PART NO. TMK500-05

7-pc. Optional Extra Fixturing Kit | Gross Weight: 5 kg



AGH230	MSA46-HD	MLD600	XPV830	MVDF42
1x	2x	2x	1x	1x

PART NO. TA66045-K1

Portable Fixturpoint Table with 12-pc. Fixturing Kit | Gross Weight: 16 kg



TA66045	UBN110	TBXS2538	T50737
1x	4x	4x	4x

PART NO. TDQ612075-K1

Rhino Cart with 66-pc. Fixturing Kit | Gross Weight: 220 kg

MOST POPULAR KIT



TDQ612075	UDN6150	PT07K	PT09K	TCX6210	T64217
1x	2x	2x	2x	2x	2x



T60630	T60304	T60305	T64211	T64216	T50737
8x	2x	2x	4x	8x	12x



T65055	T64201	T64203	T64205
10x	2x	4x	4x

RHINO CART & MANIPULATOR FIXTURING KITS

PART NO. TDQ612075-K2

Rhino Cart with 122-pc. Fixturing Kit | Gross Weight: 238 kg



TDQ612075	UDN6150	PT09K	T51655	UDV45M	T64217
1x	4x	2x	2x	4x	6x



T64211	T64216	T60210	T60305	T60310	T60320
4x	20x	2x	2x	2x	5x



T60330	T60505	T60510	T60517	T60630	T65055
4x	2x	4x	3x	4x	42x



T64201	T65020	T932607	T65804
2x	4x	2x	2x

PART NO. TU65050-K1

Manipulator with 30-pc. Fixturing Kit | Gross Weight: 109 kg

NEW MANIPULATOR KIT



TU65050	UDN6150	PT09K	T65055	T64205	T60304
1x	2x	2x	6x	4x	2x



T60305	T64216	T50737
2x	4x	8x

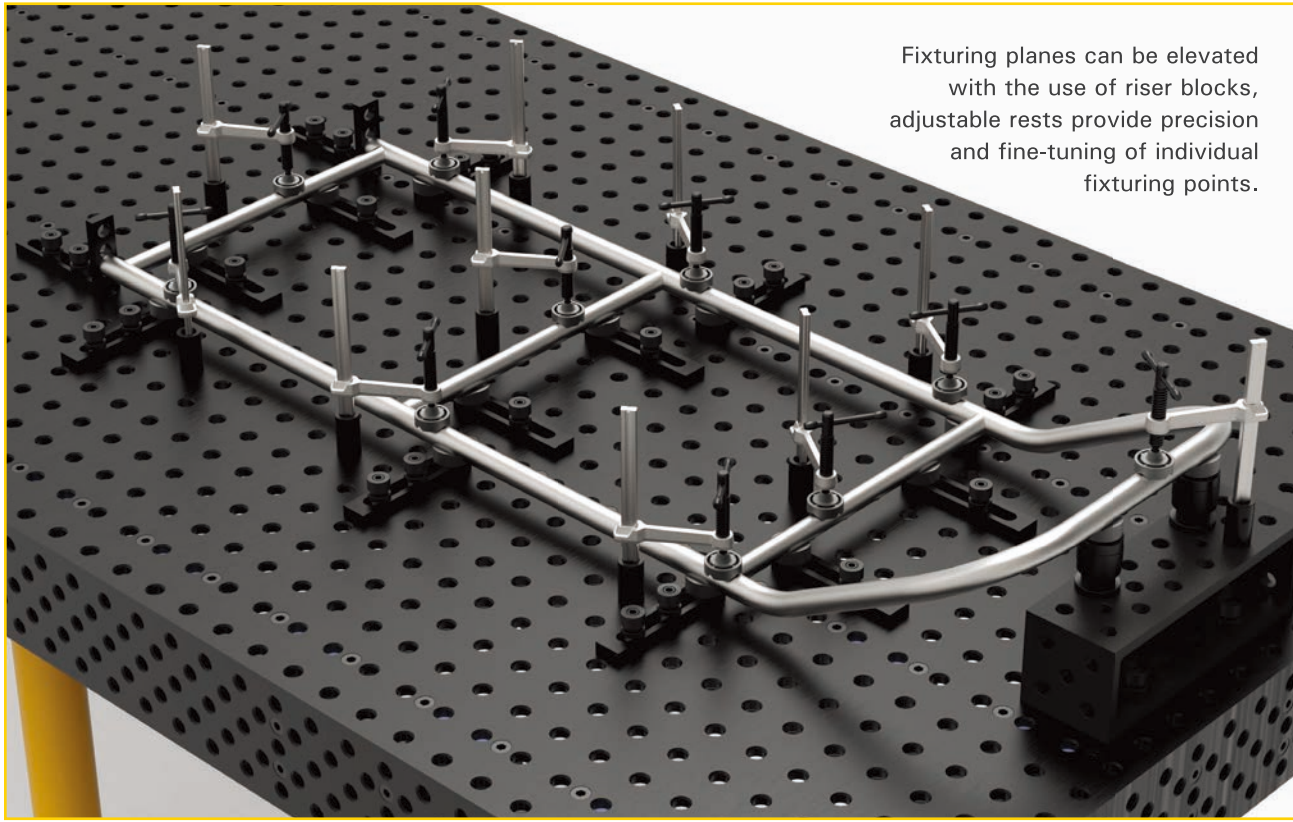

Fixturing planes can be elevated with the use of riser blocks, adjustable rests provide precision and fine-tuning of individual fixturing points.



Laser-cut fixturing components can be joined with modular elements to provide precise positioning, and alignment while maintaining consistency and accuracy.

FIXTURING EXAMPLES

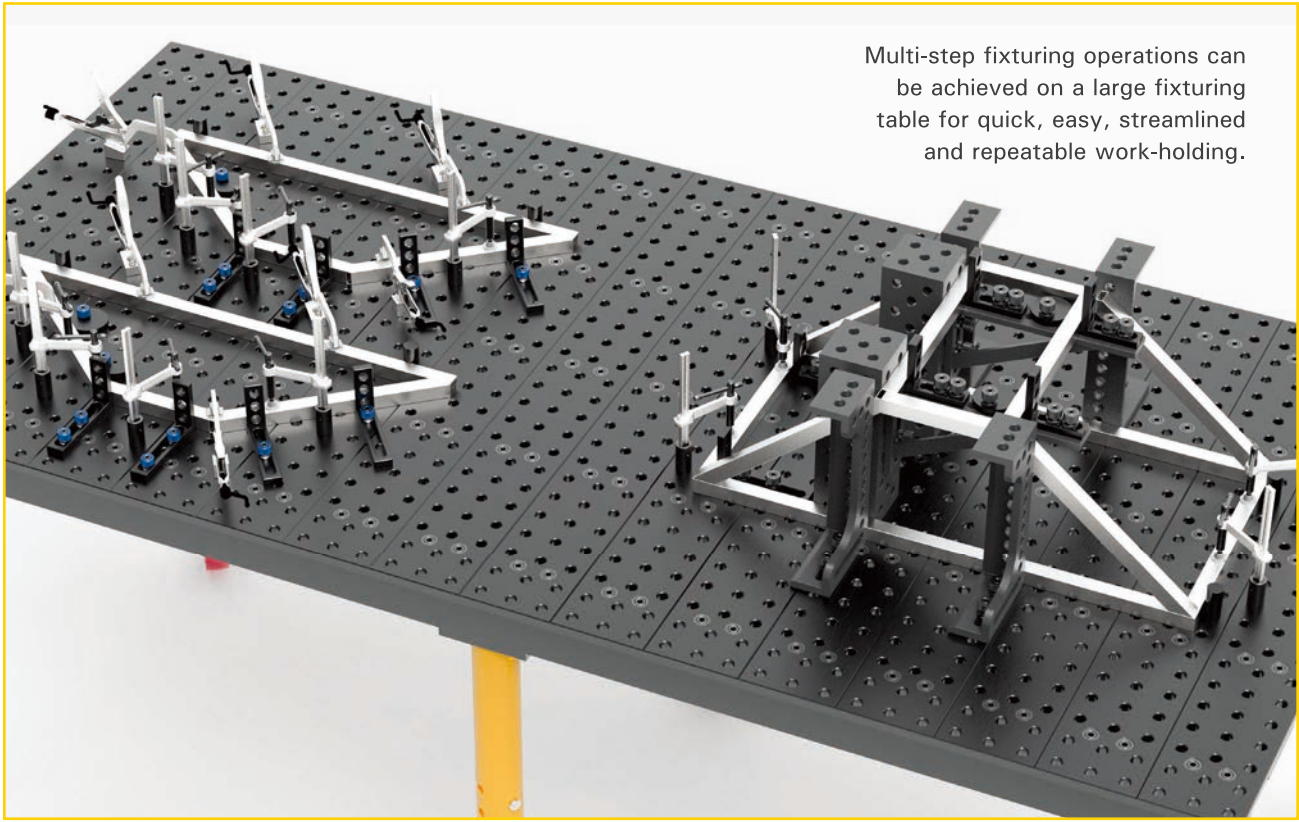

Multi-step fixturing operations can be achieved on a large fixturing table for quick, easy, streamlined and repeatable work-holding.

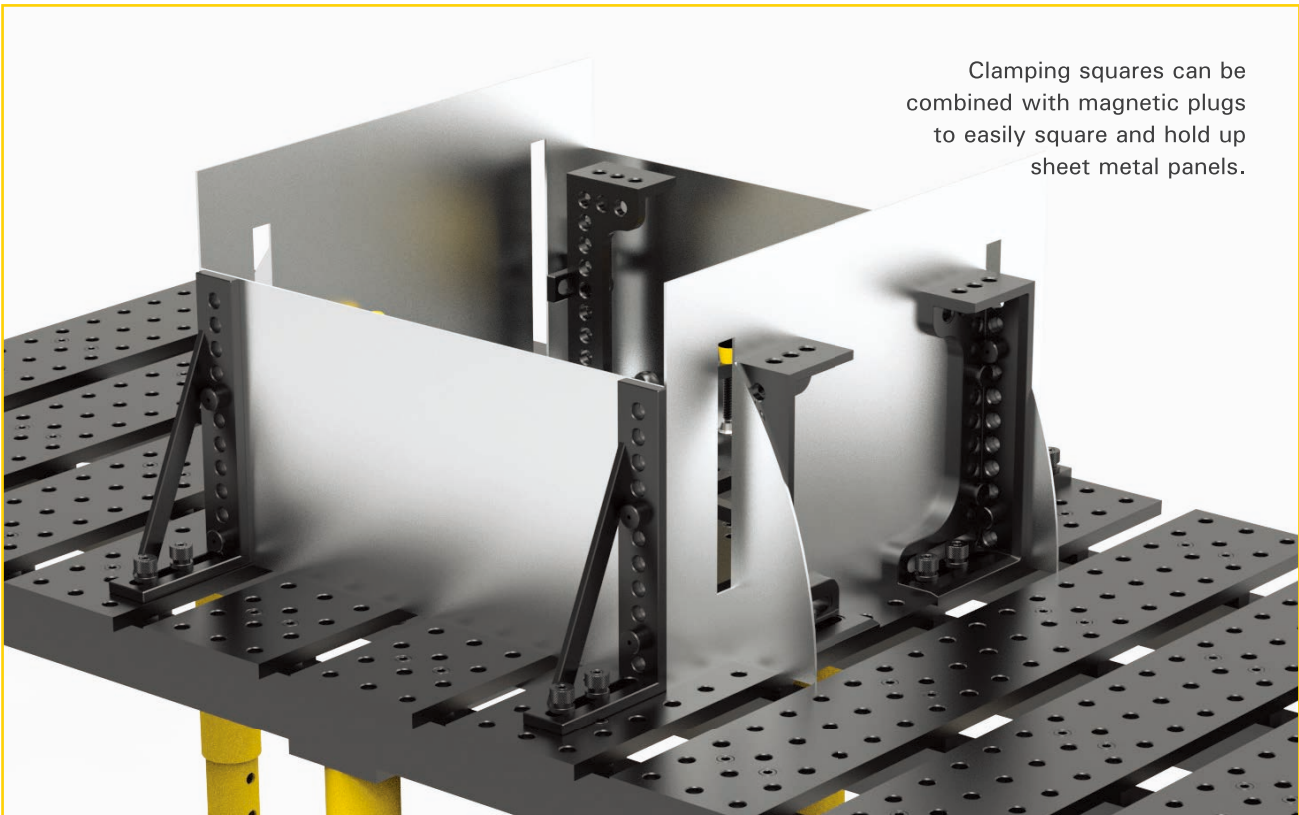

Clamping squares can be combined with magnetic plugs to easily square and hold up sheet metal panels.



TOGGLE CLAMPS

Ideal time-saving jig and fixture clamps.

www.goodhandinc.com



VERTICAL HANDLE

Hold Down Action

PUSH / PULL

Straight Line Action

SIDE MOUNT

F-TYPE

Pull Down Action

YOKE ASSEMBLIES

HORIZONTAL HANDLE

Hold Down Action

LATCH TYPE

Pull Action

TOGGLE PLIERS

Squeeze Action

PNEUMATIC POWER

HEAVY DUTY WELDABLE

Hold Down Action



COMPONENTS

Standard Machine Parts & Tooling Components.

www.valtrainc.com

- BEDDING SUPPORTS
- FORGED ADJUSTA-CLAMPS
- CENTER CAM CLAMPS
- HANDWHEELS
- CAM ACTION CLAMPS
- ADJUSTABLE HANDLES
- ROTARY T-SLOT NUTS
- CAP SCREW HOOK CLAMPS
- HANDKNOBS
- LIFTING EYEBOLTS



- LEVELING PADS
- PINS & LINERS
- PLAIN EYEBOLTS
- HEAVY DUTY FIXED GLIDES
- ROTARY T-SLOT BOLTS
- SPRING STOPS
- SPEED BALL HANDLES
- CRANK HANDLES
- T-SLOT BOLTS
- T-STRAP BOLTS



STRONG HAND TOOLS®

Welding Clamps · Magnets · Pliers · Vises · Economy Welding Tables

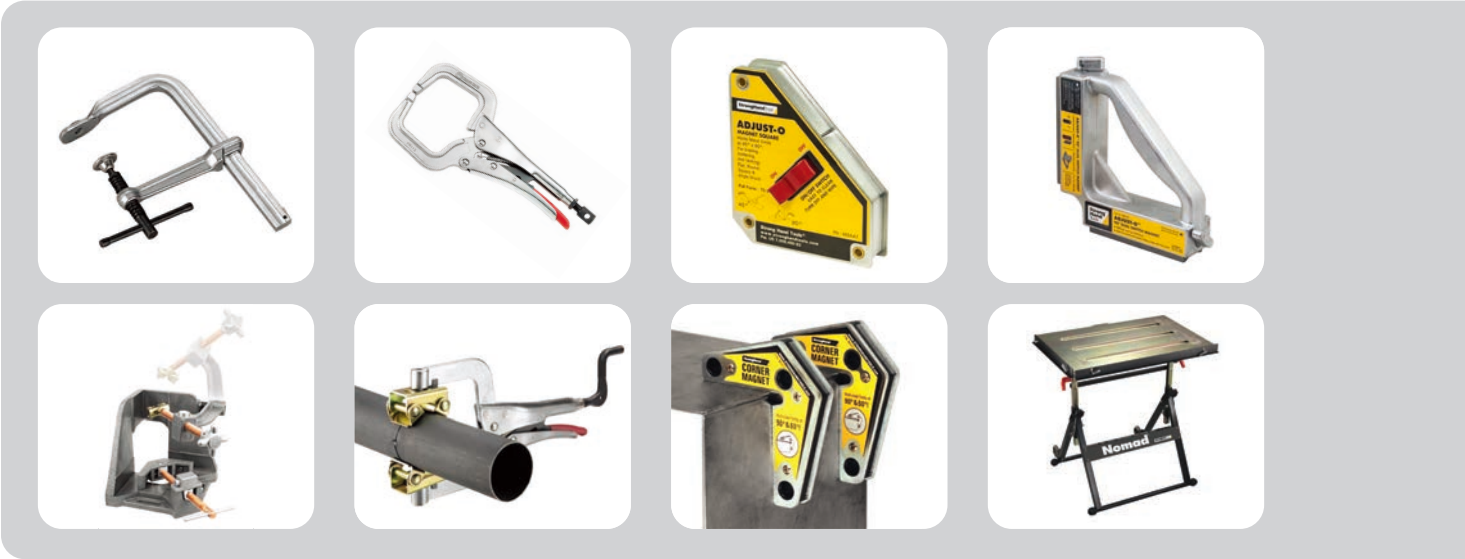

Please call 562.949.8625 to request the full line catalog.

Multi-function, time saving Strong Hand Tools® Clamps, Magnets, and Pliers are Quick Acting, so you save time and money by completing work setups faster.



THE NEXT GENERATION OF AFFORDABLE MODULAR FIXTURING.

INDIVIDUAL POSITIONABLE, REVERSIBLE TABLE PLATES

**58-62 HRC TABLETOP HARDNESS
QPQ NITRIDING TREATMENT**



Expand your capabilities in fixturing heavy duty, complex, or oversized weldments for precision welding and fabrication.



Authorized Distributor

USA Headquarters

8750 Pioneer Blvd, Santa Fe Springs, CA 90670 U.S.A.
Tel: 562-949-8625
Fax: 562-949-4875
sales@stronghandtools.com

Europe

Pražská 410/11 67401 Třebíč, Czech Republic
Tel: +420 607 088 466
Fax: +420 568 853 213
sales@stronghand.eu

Asia

No. 605 Huabo Rd, Huating Town, Jiading District, Shanghai, China 201816
Tel: +86-21-59103639
Fax: +86-21-59102951
asiasales@stronghandtools.com