

**FEpowerTools®**

# PROFESSIONAL POWER TOOLS AND ACCESSORIES

## PRODUCT CATALOG

MAGNETIC DRILLING MACHINES  
PIPE CUTTING MACHINES  
BEVELING MACHINES  
LUBRICANTS  
ABRASIVES  
ACCESSORIES  
AND MUCH MORE...



---

# FE POWERTOOLS LIGHTENS YOUR WORKLOAD EVEN IN HEAVY-DUTY CONSTRUCTION APPLICATIONS.

We are your specialist for all kinds of machine tools, such as magnetic drilling machines, sawing machines, beveling machines, and all other tools and accessories used in the metal and steel industry. Fe Powertools offers a wide range of constantly innovated magnetic drilling machines and hole cutters, which are produced in a high-tech factory in Germany. Furthermore, we specialize in various other products such as Europe-made beveling machines and pipe cutting machines from Finland. Fe Powertools stands for top quality and top service. All the Fe Powertools machines conform to the basic requirements of the relevant EC directives.

## FE POWERTOOLS IS EXCLUSIVE IMPORTER FOR:

- BDS Maschinen Magnetic drilling machines and hole cutters
- Exacttools Pipe cutting machines
- NKO beveling machines
- REMO punch and dies
- FE PBM pipe beveling machines
- Promotech beveling machines
- FCO cutting oil
- Mackma pipe/tube bending machines
- Novo Abrasive: Abrasives
- Sword bandsaws
- Promotech Punching machines
- FE Carbide Burrs

---

*Fe Powertools does its utmost to ensure that all technical information and recommendations are based upon good research and our wealth of experience. We provide the data in this catalogue in good faith, and, as such, accept no liability. We urge users to determine the suitability of the products shown for their particular intended use, and to ensure that they meet the relevant guidelines and codes for their country of intended use, as these may differ greatly from country to country. Please feel free to contact our technical staff, who would be delighted to advise you on specific regulatory issues. Fe Powertools reserves the rights to alter, delete or make obsolete any product featured in this catalogue without prior notice.*

**FEpowerTools®**

**Fe Powertools® is a registered trademark.  
We do not accept any misuse of our brand or logo.**

## CONTENT

<b>FE POWERTOOLS PROFESSIONAL MAGNETIC DRILLING MACHINES</b>	<b>4</b>
FE 30, FE 32 X, FE 36 SX, FE 36 X	5
FE 35 AUT, FE 50 X, FE 50 RL X, FE 60 RL X	6
FE 100 RL X, FE 150 RL X, FE 35 DC, FE 50 DC	7
FE Air 40 P, FE Rail 36, Technical drawings	8
Technical drawings	9
Hole cutters	10
<b>ACCESSORIES</b>	<b>12</b>
Pilot pins, Hole cutter adapters, Weldon quick change tap holders	13
Twist drills, Drill chucks, Keyless drill chucks, Taper adapters, Weldon reductions	14
Taps, Cooling oil	15
Carbide burrs	16
Countersinks	17
Magnetic chip remover, Vacuum plates, Pipe clamp systems, Universal drill stand, Power cleaner	18
Morse taper, Reamers, Adapters Weldon for twistdrills	19
Punching machines, FE 60 HP, FE 110 HP	20
FE 700 HPP, Punch and dies	21
Oilfeed twist drills chipbreaker	22
Sanding Belts and Mackma Tube bending machines	23
Novo Abrasive cutting discs, Grinding discs, steel brushes	24
FE Cutting and Grinding discs, FE Flap disc, Wire brush	25
Sword Master bandsaws	26
FE IW Impact Wrench and tooling	27
<b>PIPE CUTTING MACHINES</b>	<b>28</b>
Exact 170, Exact 170 E, Exact 220 PRO, Exact 280 PRO	29
Exact 360 PRO, Exact 170 Battery, Exact P 400 Battery, Exact V 1000	30
Sawblades Exact machines	31
<b>BEVELING MACHINES</b>	<b>32</b>
FE PBM 25, FE PBM 76, FE PBM 159 - (Pipes)	33
FE PBM 210, FE PBM 340, FE PBM 630 - (Pipes)	34
FEB 18/2, FEB 21 S, FEB 25, FEB 20 Plus	35
FEB 30/45/ R25, FEB 530/545, FEB 630/645, Cutting plates	36
UZ 12, UZ 50, B15 Air	37
B2 Air, B2 Air X	38
<b>LUBRICANTS AND CUTTING OILS</b>	<b>40</b>

# PROFESSIONAL DRILLING MACHINES

for demanding conditions

Fe Powertools magnetic drilling machines are for serious business. All the magnetic drilling machines come with the strongest original EIBENSTOCK motors manufactured in Germany.

Fe Powertools magnetic drilling machines are equipped with the strongest dual-coil electromagnets, have a user-friendly ergonomic design and all electronic PCB Boards come from European suppliers. The new Fe Powertools magnetic drilling machine line is specially designed so that most parts are interchangeable, including the standard, magnet and switches. All machines come with an automatic coolant system mounted cleverly on top of the machines. All machines come in a strong PP or metal box, this protects the machine during heavy transport.

**IF FE POWERTOOLS CAN'T  
HELP YOU, NOBODY CAN.**

Fe Powertools is constantly investigating the actual market situation to offer its customers the most innovative products that will get the job done quickly, easily, safely and inexpensively.

# MAGNETIC DRILLING MACHINES



**FE 30**  
MAGNETIC DRILLING MACHINE

max. ø  
30 mm

**Machine box includes:**  
FE machine with coolant system, safety chain, pilot pin, safety guidelines and users manual.



**FE 32 X**  
MAGNETIC DRILLING MACHINE

max. ø      max. ø  
32 mm      13 mm

**Machine box includes:**  
FE machine with coolant system, safety strap, pilot pin, safety guidelines and users manual.



**FE 36 SX**  
MAGNETIC DRILLING MACHINE  
HORIZONTAL

max. ø  
36 mm

**Machine box includes:**  
FE machine with coolant system, safety chain, pilot pin, safety guidelines and users manual.



**FE 36 X**  
MAGNETIC DRILLING MACHINE

max. ø  
36 mm

**Machine box includes:**  
FE machine with coolant system, safety strap, pilot pin, safety guidelines and users manual.

TECHNICAL INFORMATION
Motor power <b>1050 watt</b>
Spindle <b>19 mm (3/4") Weldon</b>
Hole cutter (short 30 mm) <b>ø 12 mm - ø 30 mm (1-3/16")</b>
Hole cutter (long 55 mm) <b>ø 12 mm - ø 30 mm (1-3/16")</b>
RPM <b>460 min-1</b>
Stroke <b>70 mm (3.15")</b>
Weight <b>9.9 kg (21.83 lbs)</b>
Magnet power <b>1500 kg (3304 lbs)</b>

COMES STANDARD WITH COOLING SYSTEM IN STRONG PP-BOX

TECHNICAL INFORMATION
Motor power <b>1050 watt</b>
Spindle <b>19 mm (3/4") Weldon</b>
Hole cutter (short 30 mm) <b>ø 12 mm - ø 32 mm (1-1/4")</b>
Hole cutter (long 55 mm) <b>ø 12 mm - ø 32 mm (1-1/4")</b>
Twist drill <b>ø 13 mm (1/2")</b>
RPM <b>460 min-1</b>
Stroke <b>160 mm (6.29")</b>
Weight <b>12 kg (26,8 lbs)</b>
Magnet power <b>1500 kg (3304 lbs)</b>

COMES STANDARD WITH COOLING SYSTEM IN STRONG PP-BOX

TECHNICAL INFORMATION
Motor power <b>1080 watt</b>
Spindle <b>19 mm (3/4") Weldon</b>
Hole cutter (short 30 mm) <b>ø 12 mm - ø 36 mm (1-7/16")</b>
RPM <b>400 min-1</b>
Stroke <b>39 mm (1.54")</b>
Handle position <b>Comes standard with ratchet</b>
Weight <b>11 kg (24.2 lbs)</b>
Height <b>Only 18 cm</b>
Magnet power <b>1500 kg (3304 lbs)</b>

COMES STANDARD WITH COOLING SYSTEM IN A STEELCASE

TECHNICAL INFORMATION
Motor power <b>920 watt</b>
Spindle <b>19 mm (3/4") Weldon</b>
Hole cutter (short 30 mm) <b>ø 12 mm - ø 36 mm (1- 7/16")</b>
Hole cutter (long 55 mm) <b>ø 12 mm - ø 36 mm (1- 7/16")</b>
RPM <b>350 min-1</b>
Stroke <b>70 mm (2-3/4")</b>
Weight <b>10 kg (21,5 lbs)</b>
Magnet power <b>1000 kg (2150 lbs)</b>

COMES STANDARD WITH COOLING SYSTEM IN STRONG PP-BOX



All our Fe Powertools magnetic drilling machines come in strong PP carrying boxes or metal case, complete with hex keys, pilot pins, cutting oil, safety strap and of course a user's manual and safety guidelines.



**FE 35 AUT**  
MAGNETIC DRILLING MACHINE  
AUTOMATIC

max. ø  
35 mm

**Machine box includes:**  
FE machine with coolant system, safety strap, pilot pin, safety guidelines and users manual.



**FE 50 X**  
MAGNETIC DRILLING MACHINE

max. ø    max. ø  
50 mm    23 mm

**Machine box includes:**  
FE machine with coolant system, safety strap, pilot pin, safety guidelines and users manual.



**FE 50 RL X**  
MAGNETIC DRILLING MACHINE

max. ø    max. ø    M5-M16    max. ø  
50 mm    23 mm                         50 mm

**Machine box includes:**  
FE machine with coolant system, safety strap, pilot pin, safety guidelines and users manual.



**FE 60 RL X**  
MAGNETIC DRILLING MACHINE

max. ø    max. ø    M5-M20    max. ø  
60 mm    25 mm                         50 mm

**Machine box includes:**  
FE machine with coolant system, safety strap, pilot pin, safety guidelines and users manual.

TECHNICAL INFORMATION
Motor power <b>1050 watt</b>
Spindle <b>19 mm (3/4") Weldon</b>
Hole cutter (short 30 mm) <b>ø 12 mm - ø 35 mm (1-7/16")</b>
Hole cutter (long 55 mm) <b>ø 12 mm - ø 35 mm (1-7/16")</b>
RPM <b>360 min-1</b>
Stroke <b>150 mm</b>
Weight <b>15 kg (33 lbs)</b>
Magnet power <b>1500 kg (3304 lbs)</b>

COMES STANDARD WITH COOLING SYSTEM IN STRONG PP-BOX

TECHNICAL INFORMATION
Motor power <b>1150 watt</b>
Spindle <b>MT2, 19 mm (3/4") Weldon</b>
Hole cutter (short 30 mm) <b>ø 12 mm - ø 50 mm (1-1/4")</b>
Hole cutter (long 55 mm) <b>ø 12 mm - ø 50 mm (1-1/4")</b>
Twist drill <b>ø 23 mm (7/8")</b>
RPM <b>I 250 min-1 / II 450 min-1</b>
Stroke <b>160 mm (6.29")</b>
Weight <b>13 kg (26.8 lbs)</b>
Magnet power <b>1500 kg (3304 lbs)</b>

COMES STANDARD WITH COOLING SYSTEM IN STRONG PP-BOX

TECHNICAL INFORMATION
Motor power <b>1150 watt</b>
Spindle <b>MT2, 19 mm (3/4") Weldon</b>
Hole cutter (short 30 mm) <b>ø 12 mm - ø 50 mm (1-1/4")</b>
Hole cutter (long 55 mm) <b>ø 12 mm - ø 50 mm (1-1/4")</b>
Twist drill <b>ø 23 mm (7/8")</b>
Tapping <b>ø M5-M16</b>
Countersinking <b>ø 40 mm (1-9/16")</b>
RPM (variable) <b>I 50-250 min-1 / II 180-450 min-1</b>
Stroke <b>160 mm (6.29")</b>
Weight <b>13 kg (26.8 lbs)</b>
Magnet power <b>1500 kg (3304 lbs)</b>

COMES STANDARD WITH COOLING SYSTEM IN STRONG PP-BOX

TECHNICAL INFORMATION
Motor power <b>1600 watt</b>
Spindle <b>MT3, 19 mm (3/4") Weldon</b>
Hole cutter (short 30 mm) <b>ø 12 mm - ø 60 mm (1-1/4")</b>
Hole cutter (long 55 mm) <b>ø 12 mm - ø 60 mm (1-1/4")</b>
Hole cutter (extra long 75 mm) <b>ø 20 mm - ø 60 mm (1-1/4")</b>
Twist drill <b>ø 25 mm (1")</b>
Tapping <b>ø M5-M20</b>
Countersinking <b>ø 50 mm (2")</b>
RPM <b>I 70-280 min-1 / II 180-580 min-1</b>
Stroke <b>160 mm (6.29")</b>
Weight <b>15 kg (33 lbs)</b>
Magnet power <b>1500 kg (3304 lbs)</b>

COMES STANDARD WITH COOLING SYSTEM IN STRONG PP-BOX

# MAGNETIC DRILLING MACHINES



Left/ Right option  
230 V  
110 V  
**FE 100 RL X**  
MAGNETIC DRILLING MACHINE

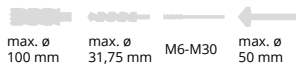

**Machine box includes:**  
FE machine with coolant system, safety chain, pilot pin, safety guidelines and users manual.



220 V  
240 V  
**FE 150 RL X**  
MAGNETIC DRILLING MACHINE



**Machine box includes:**  
FE machine with coolant system, MT4 arbor 19MM ( 32MM optional ), safety guard, tooling set and users manual.



230 V  
110 V  
**FE 35 DC**  
MAGNETIC DRILLING MACHINE



**Machine box includes:**  
FE machine with coolant system, safety chain, pilot pin, safety guidelines and users manual.



230 V  
110 V  
**FE 50 DC**  
MAGNETIC DRILLING MACHINE



**Machine box includes:**  
FE machine with coolant system, safety strap, pilot pin, safety guidelines and users manual.

TECHNICAL INFORMATION	TECHNICAL INFORMATION	TECHNICAL INFORMATION	TECHNICAL INFORMATION
Motor power <b>1800 watt</b>	Motor power <b>2300 watt</b>	Motor power <b>1050 watt</b>	Motor power <b>1150 watt</b>
Spindle <b>MT3, 19 mm (3/4") Weldon</b>	Spindle <b>Morse conus 4 – 31,75mm</b>	Spindle <b>19 mm (3/4") Weldon</b>	Spindle <b>19 mm (3/4") Weldon</b>
Hole cutter (short 30 mm) <b>ø 12 mm - ø 100 mm (4")</b>	Hole cutter (short 30 mm) <b>ø 12 mm - ø 150 mm</b>	Hole cutter (short 35 mm) <b>ø 12 mm - ø 35 mm</b>	Hole cutter (short 30 mm) <b>ø 12 mm - ø 50 mm ( 1-7/16")</b>
Hole cutter (long 55 mm) <b>ø 12 mm - ø 100 mm (4")</b>	Twist drill <b>ø 47 mm</b>	Hole cutter (long 55 mm) <b>ø 12 mm - ø 35 mm</b>	Hole cutter (long 55 mm) <b>ø 12 mm - ø 50 mm ( 1-7/16")</b>
Hole cutter (extra long 75/110 mm) <b>ø 20 mm - ø 100 mm (4")</b>	Tapping max. <b>ø M42</b>	RPM <b>450 min-1</b>	RPM <b>250 min-1/450 min-1</b>
Countersinking <b>ø 50 mm (2")</b>	Motor speed <b>I 55-85 II 100-150 III 200-300 IV 350-520</b>	Stroke <b>160 mm (6.29")</b>	Stroke <b>160 mm (6.29")</b>
Reaming <b>ø 31.75 mm (1-1/4")</b>	Stroke <b>260 mm</b>	Weight <b>12 kg (26,8 lbs)</b>	Weight <b>13 kg (26.8 lbs)</b>
Twist drills <b>ø 31.75 mm (1-1/4")</b>	Weight <b>31 kg</b>	Magnet power <b>1500 kg (3304 lbs)</b>	Magnet power <b>1500 kg (3304 lbs)</b>
Tapping <b>M6 - M30</b>	Magnet power <b>2550 kg</b>		
RPM <b>I 40-140 min-1 / II 120-480 min-1</b>			
Stroke <b>250 mm (9.85")</b>			
Weight <b>27 kg (59.5 lbs)</b>			
Magnet power <b>3500 kg (7716 lbs)</b>			

COMES STANDARD WITH COOLING SYSTEM IN STRONG PP-BOX

COMES STANDARD WITH COOLING SYSTEM IN A STEELCASE

COMES STANDARD WITH COOLING SYSTEM IN STRONG PP-BOX

COMES STANDARD WITH COOLING SYSTEM IN STRONG PP-BOX

**PERMANENT MAGNET FOR PIPES AND FLAT MATERIAL**



**FE AIR 40 P**  
MAGNETIC DRILLING MACHINE

max.  $\phi$  35 mm    max.  $\phi$  23 mm

**Machine box includes:**  
FE machine with coolant system, safety chain, pilot pin, safety guidelines and users manual.



**FE RAIL 36**  
MAGNETIC DRILLING MACHINE

max.  $\phi$  35 mm

**Machine box includes:**  
FE machine with coolant system, pilot pin, safety guidelines and users manual.

**TECHNICAL INFORMATION**

Motor power  
**830 watt**

Air  
**1000 L/min**

Spindle  
**Keyless MT2-19 mm Weldon**

Hole cutter (short 30 mm)  
 **$\phi$  12 mm -  $\phi$  35 mm (1.3")**

Hole cutter (long 55 mm)  
 **$\phi$  12 mm -  $\phi$  35 mm (1.3")**

Twist drills  
 **$\phi$  23 mm (7/8")**

RPM  
**290-575 min-1**

Stroke  
**160 mm**

Weight  
**17.5 kg (38.5 lbs)**

Torque  
**27 Nm**

**EX class**  
**EX II 26 T4 IKD 110° C**

Air consumption  
**1000 L/min**

**COMES STANDARD WITH COOLING SYSTEM IN A STEELCASE**

**TECHNICAL INFORMATION**

Motor power  
**1.5 Kw**

Motor  
**4 stroke Honda GXH 50 (Fuel)**

Spindle  
**19 mm (3/4") Weldon**

Hole cutter (short 30 mm)  
 **$\phi$  17 mm -  $\phi$  36 mm Railcutter (1.4")**

RPM  
**150-225 min-1 / 180-580 min-1**

Stroke  
**40 mm (9.85")**

Weight  
**21.5 kg (47.3 lbs)**

**Different rail adaptors:**  
NP46, UIC 54, UIC 60 and all others on request.

**COMES STANDARD WITH COOLING SYSTEM IN A STEELCASE**

**FE 30** MAGNETIC DRILLING MACHINE

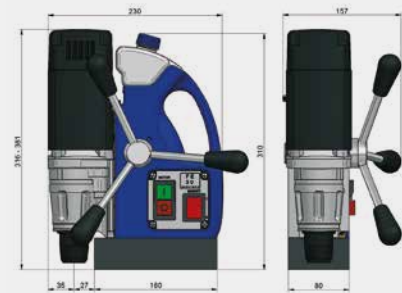

**FE 35 AUT** MAGNETIC DRILLING MACHINE

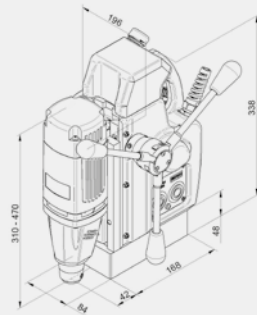

**FE 100 RL X** MAGNETIC DRILLING MACHINE

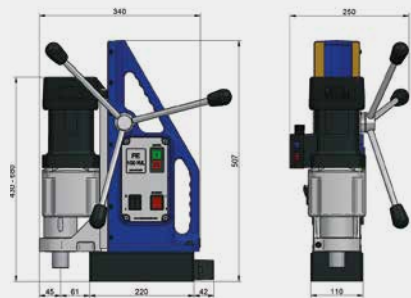

**FE AIR 40 P** MAGNETIC DRILLING MACHINE

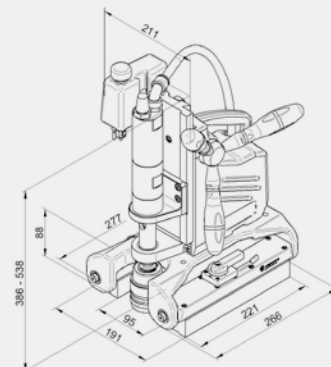



# MAGNETIC DRILLING MACHINES

## TECHNICAL MEASUREMENT DRAWINGS

**FE 32 X** MAGNETIC DRILLING MACHINE



**FE 36 SX** MAGNETIC DRILLING MACHINE

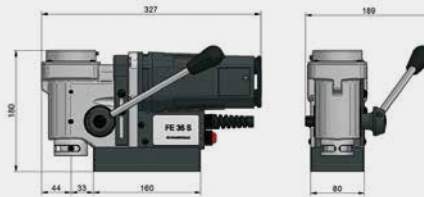

**FE 36 X** MAGNETIC DRILLING MACHINE

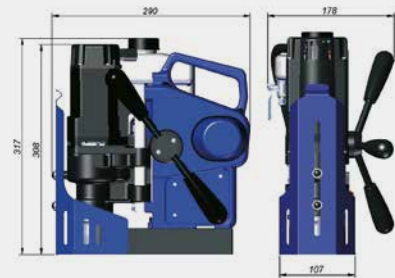

**FE 50 X** MAGNETIC DRILLING MACHINE

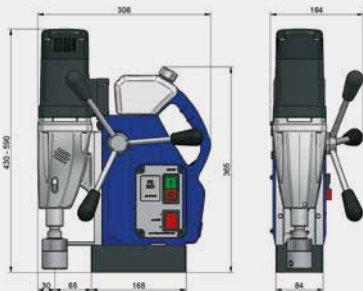

**FE 50 RL X** MAGNETIC DRILLING MACHINE

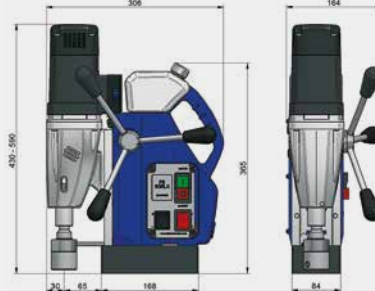

**FE 60 RL X** MAGNETIC DRILLING MACHINE

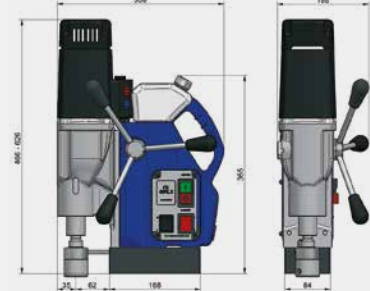

**FE 150 RL X** MAGNETIC DRILLING MACHINE

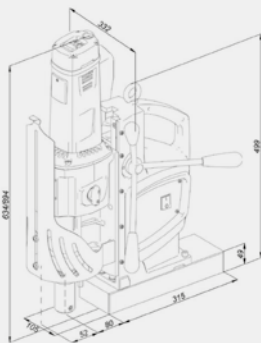

**FE 35 DC** MAGNETIC DRILLING MACHINE

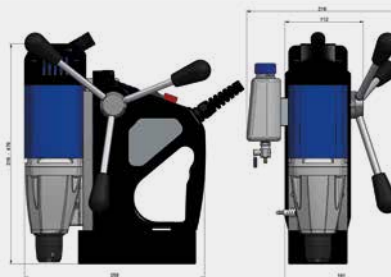

**FE 50 DC** MAGNETIC DRILLING MACHINE

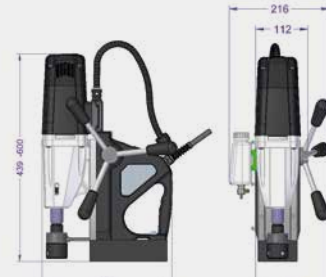

**FE RAIL 36** MAGNETIC DRILLING MACHINE

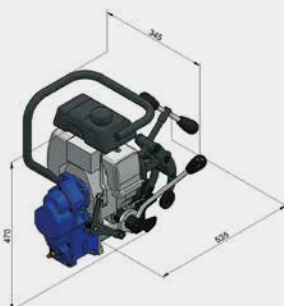



**HSS ANNULAR CUTTERS**

For cutting standard steel

ARTICLE NR.	MAX. CUTTING DEPTH	Ø SIZES	CONNECTION
FE 30 HSS Hole cutter	30 mm	12 - 130 mm	Weldon
FE 55 HSS Hole cutter	55 mm	12 - 130 mm	Weldon
FE 110 HSS Hole cutter	110 mm	18 - 50 mm	Weldon
FE 35 HSS Hole cutter	35 mm	12 - 60 mm	Fein



**TCT TUNGSTEN CARBIDE TIPPED CUTTERS**

FOR CUTTING TOUGHER MATERIALS LIKE STAINLESS STEEL AND HARDOX BUT ALSO STANDARD STEEL

ARTICLE NR.	MAX. CUTTING DEPTH	Ø SIZES	CONNECTION
FET 30 TCT Hole cutter	30 mm	12 - 150 mm	Weldon/Nitto
FET 50 TCT Hole cutter	55 mm	12 - 150 mm	Weldon/Nitto
FET 75 TCT Hole cutter	75 mm	18 - 150 mm	Weldon
FET 110 TCT Hole cutter	110 mm	20 - 120 mm	Weldon
FET F35 TCT Hole cutter	35 mm	12 - 60 mm	Fein



**RAILCUTTERS FETR TUNGSTEN CARBIDE TIPPED CUTTERS**

FOR CUTTING RAILBARS AND VERY TOUGH MATERIALS

ARTICLE NR.	MAX. CUTTING DEPTH	Ø SIZES	CONNECTION
FETR 30 Hole cutter	30 mm	17 - 36 mm	Weldon



**FE POWERTOOLS STEEL DRILLS OFFER DURABILITY AND LONG-LASTING PERFORMANCE, MAKING THEM A WORTHWHILE INVESTMENT FOR DIY OR PROFESSIONAL USE.**

# ACCESSORIES

Hole cutters, Taps, Twist drills, Carbide burs,  
and much more...

**BETTER PERFORMANCE WITH  
FE POWERTOOLS ACCESSORIES.**

For all kinds of applications, we can offer just the right accessory to make your work easy and comfortable. With the knowledge that we have gathered over decades regarding the actual working experiences of our customers, we know exactly what accessories will improve results and increase user comfort. The best materials have been used to manufacture our line of accessories. They are guaranteed for professional use. If by any chance you should lack an accessory in our catalogue, please feel free to contact us.

## ACCESSORIES

### PILOT PINS

THE PILOT PIN HAS 3 FUNCTIONS: TO CENTERING THE CUTTER, TRANSPORTING THE OIL TO THE MATERIAL AND PUSHING OUT THE SLUG



ARTICLE NR.	FOR	CUTTING
FEPP 75	FE 30	Ø 12 - 60 mm
FEPP 90	FE 30	Ø 61 - 130 mm
FEPP 100	FE 55	Ø 12 - 60 mm
FEPP 120	FE 55	Ø 61 - 100 mm
FEPP 275	FE 110	Ø 18 - 50 mm
FEPP 75	FE 30	Ø 18 - 60 mm
FEPP 90	FE 30	Ø 61 - 130 mm
FEPP 100	FE 50	Ø 12 - 60 mm
FEPP 120	FE 50	Ø 61 - 100 mm
FEPP 245	FE 75	Ø 18 - 120 mm
FEPP 275	FE 110	Ø 12 - 60 mm
FEPP 275	FE 110	Ø 61 - 120 mm
FEPP 96	FE F30	Ø 14 - 60 mm
FEPP 75	FE R30	Ø 17 - 36 mm

### HOLE CUTTER ADAPTERS FEHC



ARTICLE NR.	DESCRIPTION	MACHINE SIDE	HOLE CUTTER SIDE
FEHCA 001	Drill Chuck Adapter	Weldon 19 mm (3/4")	1/2" x 20 NF
FEHCA 002	Adapter (including pilot pin FEPP 125)	Weldon 19 mm (3/4")	FEIN M18 x 6 P 1.5
FEHCA 003	Adapter (including pilot pin FEPP 115)	Weldon 19 mm (3/4")	Weldon 19 mm (3/4")
FEHCA 004	Adapter (including pilot pin FEPP 107 and FEPP 125)	Fein Quick-in	Weldon 19 mm (3/4")
FEHCA 005	Adapter with Nitto shank (including pilot pin FEPP 107)	Nitto "One-Touch"	Weldon 19 mm (3/4")
FEHCA 006	Adapter for Hole Cutters with thread M16 x 1.5 (including FEPP)	Weldon 19 mm (3/4")	M16 x 1.5
FEHCA 008.50	Shank extension 50 mm	Weldon 19 mm (3/4")	Weldon 19 mm (3/4")
FEHCA 008.75	Shank extension 75 mm	Weldon 19 mm (3/4")	Weldon 19 mm (3/4")
FEHCA 008.100	Shank extension 100 mm	Weldon 19 mm (3/4")	Weldon 19 mm (3/4")

### WELDON QUICK CHANGE TAP HOLDERS FEMTE



ARTICLE NR.	THREAD	SHANK Ø	SQUARE
FEMTE 001.10	M10 DIN376	7	5.5
FEMTE 001.12	M12 DIN376	9	7
FEMTE 001.14	M14 DIN376	11	9
FEMTE 001.16	M16 DIN376	12	9
FEMTE 001.18	M18 DIN376	14	11
FEMTE 001.20	M20 DIN376	16	12
FEMTE 001.22	M22 DIN376	18	14.5
FEMTE 001.24	M24 DIN376	18	14.5
FEMTE 001.27	M27 DIN376	20	16
FEMTE 001.30	M30 DIN376	22	18



**TWIST DRILLS FE**

ARTICLE NR.	DESCRIPTION
FE 100	HSS twist drill DIN 338 roll forged. 0.3 - 20.0 mm ascending by 0.1 mm
FE 105	HSS twist drill DIN 338 fully ground - splitpoint. 0.5 - 20.0 mm ascending by 0.1 mm
FE 106	HSS-E (Co 5) twist drill DIN 338 fully ground - splitpoint. 1.0 - 10.0 mm ascending by 0.1 mm 10.2 / 10.5 / 11 / 11.2 / 11.5 mm, 12.0 - 16.0 mm ascending by 0.5 mm
FE 103	HSS taper shank drill DIN 345 (Morse Taper). 10.0 - 50.0 mm ascending by 0.5 mm, 50.0 - 60.0 mm ascending by 1.0 mm
FE 108	HSS taper shank drill DIN 345 - Milled - Long Series. 9.0 - 30.0 mm ascending by 0.5 mm, 30.0 - 50.0 mm ascending by 1.0 mm
FE 113	HSS Twist drill DIN1897 Short Stroke fully ground 3.0-13.0 mm ascending by 0.5 mm



**DRILL CHUCK FEKDC**

ARTICLE NR.	TAPER BORE	CHUCK SIZE
FEKDC 13.001	DIN238 - B16	1 - 13 mm
FEKDC 16.001	DIN238 - B16	2.5 - 16 mm
FEKDC 13.002	1/2" x 20 NF	1 - 13 mm
FEKDC 16.002	1/2" x 20 NF	2.5 - 16 mm



**KEYLESS DRILL CHUCKS FEKDC**

ARTICLE NR.	TAPER BORE	CHUCK SIZE
FEKDC 13.003	DIN238 - B16	1 - 13 mm
FEKDC 16.003	DIN238 - B16	3 - 16 mm
FEKDC 13.004	1/2" x 20 NF	1 - 13 mm
FEKDC 16.004	1/2" x 20 NF	3 - 16 mm



**TAPER ADAPTERS FEDTA**

ARTICLE NR.	DIN NORM
FEDTA 001.216	DIN238 - MT2/B16
FEDTA 001.316	DIN238 - MT3/B16
FEDTA 001.218	DIN238 - MT2/B18
FEDTA 001.318	DIN238 - MT3/B18
FEDTA 001.416	DIN238 - MT4/B16
FEDTA 001.418	DIN238 - MT4/B18



**WELDON REDUCTION FEHCA**

ARTICLE NR.	DIN NORM
FEHCA007	Reduction from 31.75 mm (1-1/4") Weldon 19 mm (3/4") Weldon

ACCESSORIES



**TAPS**  
HIGH-QUALITY HSS TAPS



ARTICLE NR.	DESCRIPTION
FE 200.100	Machine taps HSSE form B DIN 376 M3 up to M52
FE 200.101	Machine taps HSSE form B DIN 371 M2 up to M10
FE 200.103	Machine taps HSSE form C/35° DIN 376 M3 up to M52
FE 200.104	Machine taps HSSE form C/35° DIN 371 M2 up to M10
FE 220.100080	Machine tap M8 DIN379/B Weldon
FE 220.100100	Machinetap M10 DIN379/B Weldon
FE 220.100120	Machinetap M12 DIN379/B Weldon
FE 220.100160	Machinetap M16 DIN379/B Weldon
FE220.100200	Machinetap M20 DIN379/B Weldon



**OUR PROGRAM OF TAPS CONSISTS OF:**

Inner thread: M1-M110, BSW1/16"-BSW3", BSF3/16"-BSF1", BA0-BA6, UNC No. 1 - UNC2", UNF No. 0 - UNF1.1/2", UNEF1/4"-UNEF1", G1/8"-G4", PG7-PG48, Tr10-Tr32, W19,9-W31,8, Rc1(BSPT)/16"-Rc2", RP(BSPP)1/16"-Rp2, NPT1/16"-NPT2", NPTF1/16"-NPTF2", NPS1/16"-NPS2"

Outer thread: M1-M110, BSW1/16"-BSW3", BSF3/16"-BSF1", BA0-BA6, UNC No. 1 - UNC2", UNF No. 0 - UNF1.1/2", UNEF No. 12-UNEF1.1/2", G1/8"-G4", R(BSPT)1/\*"-1.1/4", NPT1/16"-NPT2", NPTF1/8"-NPTF1", 8-UN1.1/8"-8-UN2.1/2"



**FE COOLING/CUTTING OIL**

ARTICLE NR.	DESCRIPTION
FEHS 001	Better tapping results by using FE Cooling/cutting oil spray.



**CARBIDE BURRS**

**CARBIDE 12X25 MM SHANK CONNECTION 6 MM**

ARTICLE NR.		DESCRIPTION
FE801.1201	B	Carbide burr Cylindral with end cut 12x25 mm - 6 mm
FE801.1202	A	Carbide burr cylindral without end cut 12x25 mm - 6 mm
FE802.1201	C	Carbide burr cylindral radius end 12x25 mm - 6 mm
FE803.1201	F	Carbide burr tree shape radius end 12x25 mm - 6 mm
FE803.1202	G	Carbide burr tree shape point end 12x25 mm - 6 mm
FE804.1201	L	Carbide burr conical radius end 12x25 mm - 6 mm
FE805.1201	E	Carbide burr oval 12x25 mm - 6 mm



**CARBIDE 10X20 MM SHANK CONNECTION 6 MM**

ARTICLE NR.		DESCRIPTION
FE801.1001	B	Carbide burr Cylindral with end cut 10x20 mm - 6 mm
FE801.1002	A	Carbide burr cylindral without end cut 10x20 mm - 6 mm
FE802.1001	C	Carbide burr cylindral radius end 10x20 mm - 6 mm
FE803.1001	F	Carbide burr tree shape radius end 10x20 mm - 6 mm
FE803.1002	G	Carbide burr tree shape point end 10x20 mm - 6 mm
FE804.1001	L	Carbide burr conical radius end 10x20 mm - 6 mm
FE805.1001	E	Carbide burr oval 10x20 mm - 6 mm



**CARBIDE 16X25 MM SHANK CONNECTION 6 MM**

ARTICLE NR.		DESCRIPTION
FE801.1601	B	Carbide burr Cylindral with end cut 16x25 mm - 6 mm
FE801.1602	A	Carbide burr cylindral without end cut 16x25 mm - 6 mm
FE802.1601	C	Carbide burr cylindral radius end 16x25 mm - 6 mm
FE803.1601	F	Carbide burr tree shape radius end 16x25 mm - 6 mm
FE803.1602	G	Carbide burr tree shape point end 16x25 mm - 6 mm
FE804.1601	L	Carbide burr conical radius end 16x25 mm - 6 mm
FE805.1601	E	Carbide burr oval 16x25 mm - 6 mm



**CARBIDE 12X25 MM SHANK CONNECTION 8 MM**

ARTICLE NR.		DESCRIPTION
FE811.1201	B	Carbide burr Cylindral with end cut 12x25 mm - 8 mm
FE811.1202	A	Carbide burr cylindral without end cut 12x25 mm - 8 mm
FE812.1201	C	Carbide burr cylindral radius end 12x25 mm - 8 mm
FE813.1201	F	Carbide burr tree shape radius end 12x25 mm - 8 mm
FE813.1202	G	Carbide burr tree shape point end 12x25 mm - 8 mm
FE814.1201	L	Carbide burr conical radius end 12x25 mm - 8 mm



**CARBIDE 12X25 MM SHANK CONNECTION 6 MM ALUMINIUM**

ARTICLE NR.		DESCRIPTION
FE821.1201	B	Carbide burr Cylindral with end cut 12x25 mm - 6 mm ALU
FE821.1202	A	Carbide burr cylindral without end cut 12x25 mm - 6 mm ALU
FE822.1201	C	Carbide burr cylindral radius end 12x25 mm - 6 mm ALU
FE823.1201	F	Carbide burr tree shape radius end 12x25 mm - 6 mm ALU
FE823.1202	G	Carbide burr tree shape point end 12x25 mm - 6 mm ALU
FE824.1201	L	Carbide burr conical radius end 12x25 mm - 6 mm ALU



ACCESSORIES



**FE COUNTERSINKS**

**COUNTERSINK WITH SHANK CONNECTION**

ARTICLE NR.	DESCRIPTION
150.100063	Countersink 6,3 mm 90° DIN 335C
150.100083	Countersink 8,3 mm 90° DIN 335C
150.100104	Countersink 10,4 mm 90° DIN 335C
150.100124	Countersink 12,4 mm 90° DIN 335C
150.100165	Countersink 16,5 mm 90° DIN 335C
150.100190	Countersink 19,0 mm 90° DIN 335C
150.100205	Countersink 20,5 mm 90° DIN 335C
150.100250	Countersink 25,0 mm 90° DIN 335C
150.100310	Countersink 31,0 mm 90° DIN 335C
150.100400	Countersink 40,0 mm 90° DIN335C
150.100500	Countersink 50,0 mm 90° DIN335C



**FE COUNTERSINK WITH MT**

**CONNECTION MT**

ARTICLE NR.	DESCRIPTION
151.100300	Countersink 30,0 mm 90° DIN335 MK2 form D
151.100400	Countersink 40,0 mm 90° DIN335 MK3 form D
151.100500	Countersink 50,0 mm 90° DIN335 MK3 form D



**FE COUNTERSINK HSS-ALCRO 90°**

**SHANK CONNECTION**

ARTICLE NR.	DESCRIPTION
152.100063	Countersink 6,3 mm HSS-ALCRO 90° P-PLUS DIN335
152.100083	Countersink 8,3 mm HSS-ALCRO 90° P-PLUS DIN335
152.100104	Countersink 10,4 mm HSS-ALCRO 90° P-PLUS DIN335
152.100124	Countersink 12,4 mm HSS-ALCRO 90° P-PLUS DIN335
152.100165	Countersink 16,5 mm HSS-ALCRO 90° P-PLUS DIN335
152.100205	Countersink 20,5 mm HSS-ALCRO 90° P-PLUS DIN335
152.100250	Countersink 25,0 mm HSS-ALCRO 90° P-PLUS DIN335
152.100310	Countersink 31,0 mm HSS-ALCRO 90° P-PLUS DIN335



**FECS COUNTERSINKS**

**WELDON CONNECTION**

ARTICLE NR.	DESCRIPTION
FECS 19	10-19 mm
FECS 205	10-20,5 mm
FECS 25	10-25 mm
FECS 30	10-30 mm
FECS 40	10-40 mm
FECS 50	15-55 mm
FECSSET01	FEC Set Countersink 6 pcs



**FECD 004**



**FECD 003**



**FECD 005**



**FECD 006**



**FECD002**



**POW 200**

**FEMC 001**



ARTICLE NR.	PRODUCT	DESCRIPTION
FEMC 001	Magnetic Chip Remover	Clean your workspace
FECD 003	Vacuum Plate Round	For non magnetic materials, clamping system with vacuum motor
FECD 004	Vacuum Plate Oval	For non magnetic materials, clamping system with vacuum motor. 2 suction surfaces
FECD 006	Pipe Clamp System	For FE 100 R/L (For pipes 150-500 mm). Easily cut holes in pipes and tubes
FECD 005	Pipe Clamp System	For FE 30, 32X, 32 R/LX, 50X and 50 R/LX (For pipes: 80 - 250 mm). Easily cut holes in pipes and tubes
FECD 002	Universal drill stand (ø 43 mm)	For commercially available handdrills with a collar ø 43 mm
POW 200	Power Cleaner	The multi functional tool for removing chips and cleaning the work surface. Chiphook with brush and protective shield!

ACCESSORIES

MORSE TAPER - WELDON CONNECTIONS FEMT



ARTICLE NR.	MORSE TAPER	HOLE CUTTER SHANK	OPERATION	LUBRICATION
FEMT219	MT 2	19 mm (3/4") Weldon	Manual	Manual
FEMT319	MT 3	19 mm (3/4") Weldon	Manual	Manual
FEMT419	MT 4	19 mm (3/4") Weldon	Manual	Manual
FEMT232	MT 2	32 mm (1-1/4") Weldon	Manual	Manual
FEMT332	MT 3	32 mm (1-1/4") Weldon	Manual	Manual
FEMT432	MT 4	32 mm (1-1/4") Weldon	Manual	Manual
FEMTA2C	MT 2	19 mm (3/4") Weldon	Quick connect	Automatic
FEMTA3C	MT 3	19 mm (3/4") Weldon	Quick connect	Automatic
FEMT219C	MT 2	19 mm (3/4") Weldon	Manual	Automatic
FEMT319C	MT 3	19 mm (3/4") Weldon	Manual	Automatic
FEMT419C	MT 4	19 mm (3/4") Weldon	Manual	Automatic
FEMT232C	MT 2	32 mm (3/4") Weldon	Manual	Automatic
FEMT332C	MT 3	32 mm (3/4") Weldon	Manual	Automatic
FEMT432C	MT 4	32 mm (3/4") Weldon	Manual	Automatic

REAMERS

ALL REAMERS ALSO AVAILABLE WITH HEXAGON CONNECTION



ARTICLE NR.	MAX. Ø	MAX. DEPTH	FROM Ø	CONNECTION	LENGHT
FE190.0140	14.0 mm	52 mm	7.0 mm	Weldon	140 mm
FE190.0190	19.0 mm	61 mm	9.5 mm	Weldon	165 mm
FE190.0200	20.0 mm	62 mm	11.0 mm	Weldon	178 mm
FE190.0220	22.0 mm	62 mm	13.0 mm	Weldon	178 mm
FE190.0240	24.0 mm	63 mm	15.0 mm	Weldon	178 mm
FE190.0140	26.0 mm	67 mm	16.0 mm	Weldon	178 mm
FE190.0280	28.0 mm	67 mm	18.5 mm	Weldon	178 mm
FE190.0300	30.0 mm	64 mm	21.0 mm	Weldon	178 mm
FE190.0320	32.0 mm	64 mm	22.5 mm	Weldon	178 mm
ARTICLE NR.	CONNECTION				
FE190.0001	Reamers 1/2" (Impact wrench) - 19 mm Weldon				
FE190.0002	Reamers 3/4" (Impact wrench) - 19 mm Weldon				

ADAPTER WELDON CONNECTION FOR TWISTDRILLS FE



ARTICLE NR.	CONNECTION
FETD 06	Adapter Weldon - ø 6.0 mm
FETD 065	Adapter Weldon - ø 6.5 mm
FETD 068	Adapter Weldon - ø 6.8 mm
FETD 07	Adapter Weldon - ø 7.0 mm
FETD 075	Adapter Weldon - ø 7.5 mm
FETD 08	Adapter Weldon - ø 8.0 mm
FETD 085	Adapter Weldon - ø 8.5 mm
FETD 09	Adapter Weldon - ø 9.0 mm
FETD 095	Adapter Weldon - ø 9.5 mm
FETD 10	Adapter Weldon - ø 10.0 mm
FETD 105	Adapter Weldon - ø 10.5 mm
FETD 11	Adapter Weldon - ø 11.0 mm
FETD 115	Adapter Weldon - ø 11.5 mm
FETD 12	Adapter Weldon - ø 12.0 mm
FETD 125	Adapter Weldon - ø 12.5 mm
FETD 13	Adapter Weldon - ø 13.0 mm

Double action - fully automated process of punching and return, Wide range of hole diameters up to 27mm, Modern construction, Intelligent control system with inching and automatic load detection, Mode indicator light, Protection against accidental start-up, Easy to handle in unusual positions, All connecting ports located at the back, Wide range of specially shaped punches and dies, Patent-pending, compact and moveable hydraulic power pack, Unique Gantry Punching Station increases both productivity and operator's comfort.



**FE 60 HP**  
PORTABLE DOUBLE ACTION HYDRAULIC PUNCHER

TECHNICAL SPECIFICATIONS	
Max. throat depth	60 mm
Max. hole	ø 27 mm
Max. oblong hole	25 x 18 mm
Punching time	5 Sec.
Max. plate thickness	13 mm
Punching power	35 Ton
Working pressure	700 bar
Weight	20 Kg



**FE 110 HP**  
PORTABLE DOUBLE ACTION HYDRAULIC PUNCHER

TECHNICAL SPECIFICATIONS	
Max. throat depth	110 mm
Max. hole	ø 27 mm
Max. oblong hole	25 x 18 mm
Punching time	8 Sec.
Max. plate thickness	16 mm
Punching power	47 Ton
Working pressure	700 bar
Weight	35 Kg

**FE 60 HP**  
MEASUREMENTS

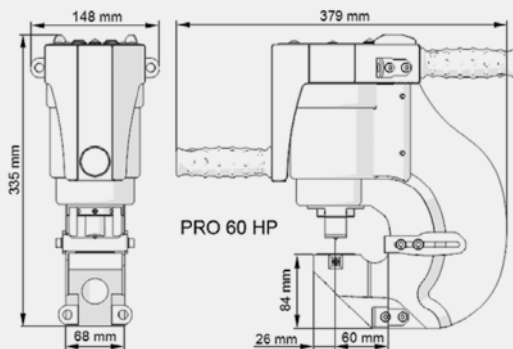

**FE 110 HP**  
MEASUREMENTS

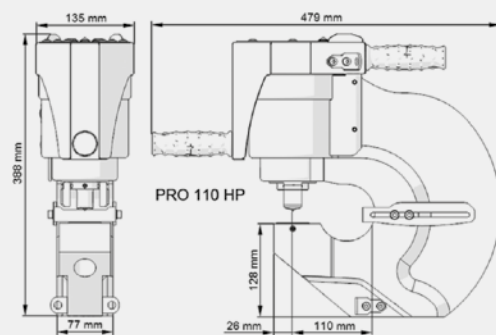

**PUNCH AND DIES**



**FE 700 HPP  
DOUBLE ACTION POWERPACK**

TECHNICAL SPECIFICATIONS	
Power supply	230V/50 Hz
Motorpower	1500 W
Working pressure	700 bar
Oil capacity	10 L



**PUNCHES AND DIES**

All the punches and dies distributed by Fe Powertools are produced in Europe. Our punch and die factory specializes in manufacturing all kinds of punches and dies for the most well-known brands. These punches and dies are for universal use.

The European factory has over 50 years of experience in producing these tools and is continuously innovating to achieve the highest quality tooling within a lightning-fast production time.

We offer universal punches and dies for all kinds of machines, including: Mubea, Kingsland, Peddinghaus, Geka, Nitto, Sunrise, Alfra and Durma.



[For more information check our website and pricelist.](#)

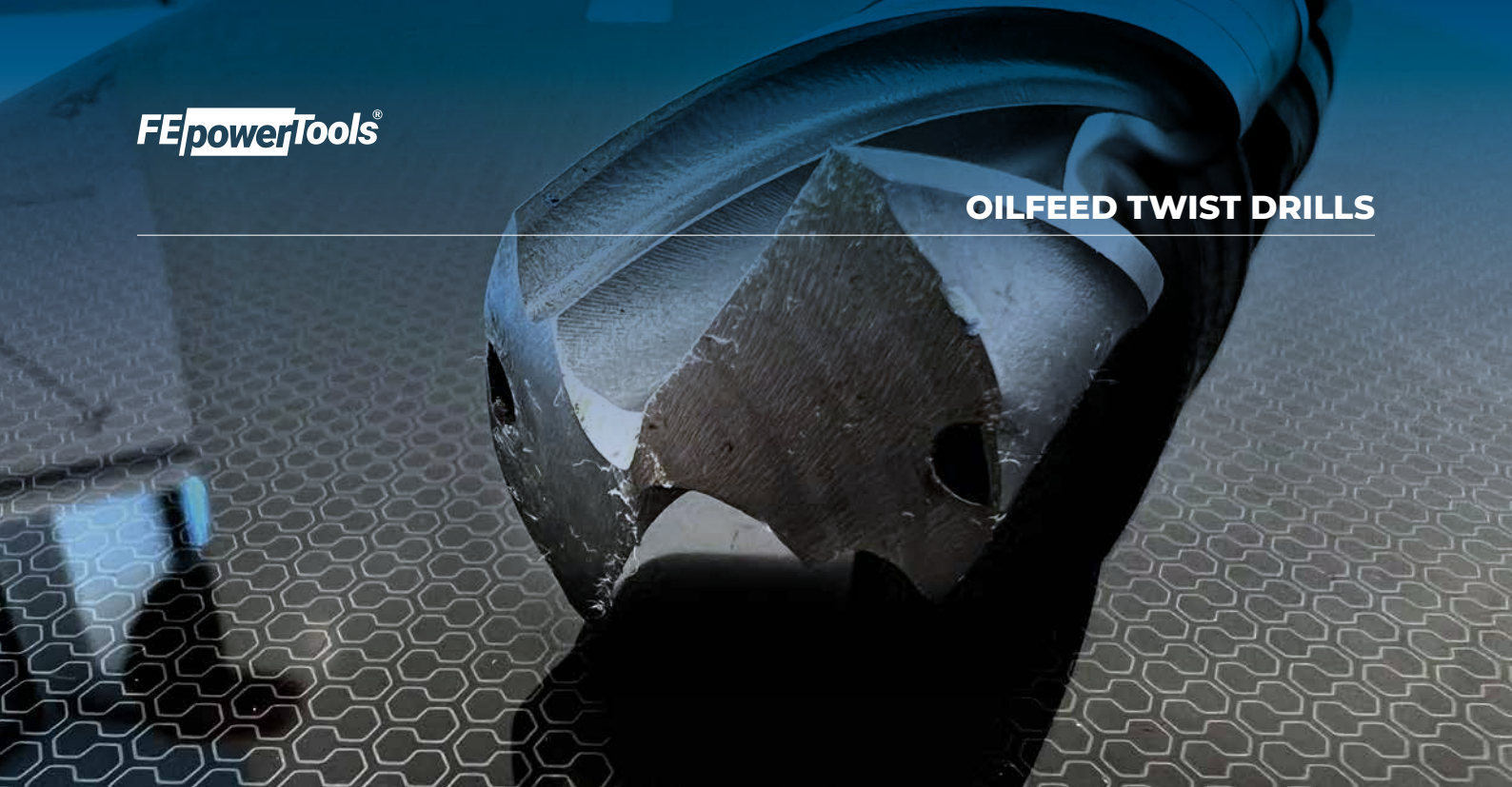

### CHIPBREAKER DRILL IN ACTION

#### Standard drill in action

This outstanding development increases drill-cutting efficiency by means of greatly improved chip control. A chipbreaker rib is positioned along the length of the flutes. It curls and breaks long, chip-forming material into small, manageable chips for easier evacuation. This prevents chips from clogging the flutes, as the smaller chips flow freely along the flutes. The Chipbreaker drill thus cuts more freely than standard drills.



Oil Tube Chipbreaker



Coolant Feed styles



Oil Tube Chipbreaker



### CHIPBREAKER DRILLS

#### Chipbreaker Coolant-Fed Drills

The benefits of providing coolant internally, directly to the drill-cutting edge, include higher cutting speeds (reduced cutting times by up to 75%), higher feed rates, longer tool life (3 to 10 times), and less frequent resharping. In addition, these drills provide a superior finish. The coolant assists in clearing chips from the drill point and its pressure forces the swarf along the flutes of the drill, facilitating drilling to greater depths without repeated withdrawal to clear swarf. Coolant tubes or holes are located away from the drill web, and they do not affect web strength. Both variants connect to all coolant systems.

### OILFEED TWIST DRILLS CHIPBREAKER

#### M2 material (HSS)

Fe Chipbreaker drills are manufactured from M2 standard High Speed Steel material. M2 products have a black oxide steam-tempered finish.

The conventional Chipbreaker drill point angle is 118°, which is suitable for the majority of high-performance applications. Upon request we can regrind the points to 170°. Coolant can be transported axially or radially.

### OILFEED TWIST DRILLS CHIPBREAKER

ARTICLE NR.	MAX. Ø	COOLANT	CONNECTION
FE790.0120 (Ascending 0.5 mm)	12 mm	Axial/radial	MT3
FE790.0275	27.5 mm	Axial/radial	MT3
FE790.0280 (Ascending 0.5 mm)	28 mm	Axial/radial	MT4
FE790.0440	44 mm	Axial/radial	MT4

## SANDING BELTS AND TUBE BENDING MACHINES



### FE SANDING BELTS

For most types of steel, including high-alloyed steels, Fe Powertools has the best sanding belts with high cutting capacity. The sanding belts are equipped with a self-sharpening ceramic grain, which is the latest innovation in the field of machining. The back of the sanding belts is made of polyester so that it is stronger and has a longer life time under an average or high working pressure with an average to hard sanding contact.

Available in grids : 36-40-60-80-100-120.

*Once you have tried this high-quality belt, you will never use another.*

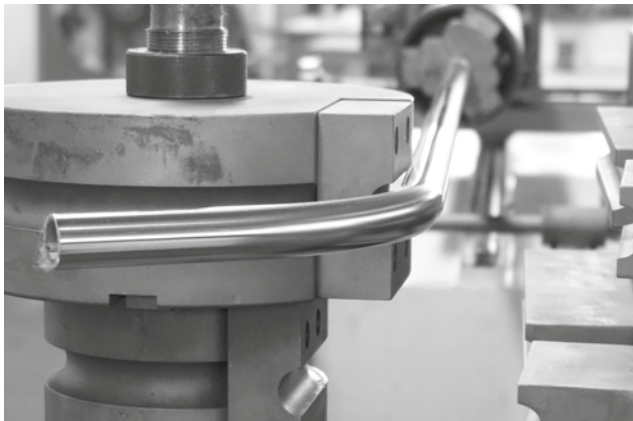

### MACKMA TUBE BENDING MACHINES

Mackma tube-bending machines from Italy are the hottest new generation machines in the market. Where other manufacturers stop with innovation, the Mackma factory seizes the opportunity to develop high-end tube-bending machines that fulfill all the wishes of today's tube-bending users. With this extended Mackma program, we offer you the possibility to bend tubes and pipes to the left or right. The patented reversible die holder was designed by Mackma, and it makes bending under the head possible as well.

All machines are supplied with the most up-to-date control systems, which can be programmed to perform up to 900 specific bending programs. Thanks to the strong inverter-controlled motor, these high-tech bending machines have low energy consumption. Mackma offers a standard 2-year warranty.

**More than 12 models available!**



[www.mackma.nl](http://www.mackma.nl)



Left bending



Right bending



Under the head bending



**NOVO ABRASIVE CUTTING DISCS  
PROFESSIONAL SERIES**

ARTICLE NR.	DESCRIPTION
331.125.100	Cutting disc Steel 125x1.0 mm
331.125.600	Cutting disc Steel 125x1.6 mm

**NOVO ABRASIVE CUTTING DISCS EXTREME  
INDUSTRIAL SERIES**

ARTICLE NR.	DESCRIPTION
332.125.100	Cutting disc Steel/Inox 125x1.0 mm EXTREME
332.230.190	Cutting disc Steel/Inox 230x1.9 mm EXTREME



**NOVO ABRASIVE GRINDING DISCS  
PROFESSIONAL SERIES**

ARTICLE NR.	DESCRIPTION
341.125.600	Grinding disc Steel 125x6.0 mm

**NOVO ABRASIVE GRINDING DISCS EXTREME  
INDUSTRIAL SERIES**

ARTICLE NR.	DESCRIPTION
342.125.600	Grinding disc Steel/Inox 125x6.0 mm EXTREME



**NOVO ABRASIVE STEEL BRUSHES  
INDUSTRIAL SERIES**

ARTICLE NR.	DESCRIPTION
350.125.001	Twist Knotted Wire Wheel brush, Steel ø 125 x22,2 mm



## ABRASIVES



### FE CUTTING DISCS

#### HIGH PERFORMANCE

The high-quality FE Abrasives product range allows you to decrease your machining operation costs due to the products' unprecedented lifetime and minimal cutting time. FE Abrasives have a highly innovative but constant production cycle. The FE brand name refers to top Quality. The promise of product quality is not unique, but FE dares to go beyond a promise:

- FE guarantees Top quality
- FE will cut your costs using patented innovations

The fully automated production cycle is controlled by sophisticated electronic instruments. The tunnels generate a precise temperature that gradually increases up to 180° C. The consistency of this cycle ensures perfect thermal treatment, resulting in optimal performance and polymerization of the discs. Research and development is sincerely FE's biggest passion. With this continual investment FE strives for continuous improvement of its products. This is fully reflected in our latest patented product innovations:

- High material machining and less material loss
- Fast cutting
- Very stable and low-vibration
- Burr-free cutting
- Clear and clean cut
- Less noise and dust
- Less energy consumption

ARTICLE NR.	DESCRIPTION
FE 300.125.100	Cutting disc for Inox/stainless steel 125 x 1.0 x 22.23 mm
FE 301.125.100	Cutting disc for metal 125 x 1.0 x 22.23 mm



### FE GRINDING DISCS

FE Powertools grinding discs Depressed Center Grinding Wheels are made for angle grinding applications including weld grinding, beveling, snagging, and other surface preparation jobs requiring moderate to heavy stock removal. The 'saucer' shape allows the operator to aggressively grind at angles less than 15 degrees, improving operator comfort. The concave shape also provides wider surface contact for grinding broad surfaces. Wheels are 6.4 MM (1/4 ") thick.

ARTICLE NR.	DESCRIPTION
FE 311.125.640	Grinding disc for metal and Inox 125 x 6.4 x 22.23 mm



### FE FLAP DISCS

You no longer have to make a calculation or test our flap discs, that we have already done for you. The FE flap discs have a high cutting capacity and retain grinding power. With our discs you do not have to exert extra hard pressure on the workpiece, which makes it much easier for the user to work. It is not only a long life which determines whether a disc is good but also determines how much material can be chipped and how fast it goes. The cheapest flapdisc in purchase is never the most economical drive in the total picture.

ARTICLE NR.	DESCRIPTION
FE 315.125.040	Size 125 x 22 grid 40 zirconium max RPM 12.200 packing 10pcs/ carton
FE 315.125.060	Size 125 x 22 grid 60 zirconium max RPM 12.200 packing 10pcs/ carton
FE 315.125.080	Size 125 x 22 grid 80 zirconium max RPM 12.200 packing 10pcs/ carton



### WIRE BRUSH

ARTICLE NR.	DESCRIPTION
FE 350.125.001	Brass-coated wire brush, Plastic handle



### SWORD BAND SAW BLADES

Band saw blades offered by SWORD are manufactured in accordance to ISO 9001 procedure. Manufacturer's brand guarantees highest quality. Since 2002, SWORD has had its own line of specially selected products sold under SWORD-MASTER brand name, manufactured by world-famous producers and delivered to SWORD for distribution under its brand. In order to ensure consistently high product quality, SWORD cooperates with the Gdańsk University of Technology where each batch of band saw blades is tested for blade, frame and back hardness as well as setting and rake angles.

Sword Master band saws, all sizes available, fast deliveries, razor-sharp prices. Let us know what you need and we offer you the best quality for the best price.



### SWORD BAND SAW BLADES ECO LINE

PRODUCT	DESCRIPTION
Sword Master A	The widest range of available tooth pitches and widths
Sword Master AP	Reinforced tooth back, high tooth chipping resistance, Wider set
Sword Master 3D Universal	Three tooth shapes on one blade, the widest range of applications, for cutting either solid sections or tubes and profiles

### SWORD BAND SAW BLADES RED LINE

PRODUCT	DESCRIPTION
Sword Master X-Treme	Aggressive M42 saw blade for high-rate production cutting
Sword Master Super	Standard M42 blade of a wide range of basic applications
Sword Master Profile max	Special M42 saw blade for cutting of all kinds of tubes, shapes and profiles

### SWORD BAND SAW BLADES SPECIALS

PRODUCT	DESCRIPTION
Sword Master P71-C	Efficient cutting of difficult to cut materials
Sword Master M51-H	High performance sawing of large, difficult to cut metals

## IMPACT WRENCH

COMES WITH 2 BATTERIES



### FE IW 18V/T650 IMPACT WRENCH

Ultra light in weight, only 2.3 KG is this 205 MM Short Impact Wrench. 18 Volt with two 4.0 Ah batteries! A brushless motor with an extra high torque that makes it last 10 x longer and is 30% more efficient. Supplied in a plastic case with extra battery and charging station.

- Ultra light 2.3 KG (including battery).
- Short machine 205 MM.
- Very powerful Torque of 650 Nm.
- No power loss and reduced heat production resulting in a longer working time.
- Intelligent IC controller protects against overheating, overloading and overcharging.
- Clear operation with 4 functions; high 650 Nm, Middle 400 Nm, Low 200 Nm and turn back (clockwise).
- Extra large control buttons.
- Metal hook for attaching to a belt.
- Lighting in handle.
- Loosen bolts in the highest torque of 1900 rpm min-1 to 500 min-1.
- Automatically stops after 5 minutes of continuous use.
- IP 54 protected.



### IMPACT RESISTANT KNEE JOINT

PRODUCT	DESCRIPTION
FE 9266500	Impact resistant knee joint of chrome-molybdenum steel ½" inner square to ½" outer square with a length of 65mm.



### 7 PIECE IMPACT SOCKET SET

PRODUCT	DESCRIPTION
250.0001	7-piece set with the most common impact sockets and accessories in ½". Impact sockets in sizes 13/17/19/21/24, a ¼" hexagon adapter to use your impact sockets in a battery toll and ½" bit holder to use your screw bits in the impact wrench.

### 15 PIECE ½" LONG IMPACT SOCKET SET

PRODUCT	DESCRIPTION
251.0001	Chrome-molybdenum in sizes 10/11/12/13/14/15/16/17/18/19/21/22/24/27/30 including 2 rings and 2 pins in handy steel storage case. These quality sockets have a length of 90 mm and are suitable for use on the heaviest impact machines.



### IMPACT RESISTANT SHORT CAPS

PRODUCT	DESCRIPTION
250.100080	M8
250.100100	M10
250.100120	M12
250.100160	M16
250.100200	M20
250.100240	M24



### IMPACT RESISTANT LONG CAPS

PRODUCT	DESCRIPTION
251.100080	M8
251.100100	M10
251.100120	M12
251.100160	M16
251.100200	M20
251.100240	M24



# PIPE CUTTING

Machines and Sawblades for the Pro



The Original  
Pipe Cutting System  
made by Exact Tools  
Designed in Finland

## THE EXACT SYSTEM: INNOVATIONS THAT RENDER PIPE HANDLING EFFORTLESS, ACCURATE AND FAST

Over the last ten years, Exact has developed a number of modern tools for pipe cutting, finishing and processing. Innovative products from Exact raise the pipe working efficiency to an entirely new level.

### The Exact system is suitable for all pipes and materials

Exact pipe cutters are suitable for all kinds of pipe materials; a single machine allows cutting pipes of greatly differing sizes. Pipe cutting is significantly faster as compared to traditional methods. The resulting surfaces are precise and of uniform quality – the pipes are ready for joining right away.

Exact pipe cutters can be used almost anywhere, since in most countries they are approved for indoor use – for example, as compared to angle grinders, the fire hazards are substantially lesser.

Exact pipe cutters are easy to move around and effortless to use, for it is not necessary to support the device while cutting. Since the cutting is fast and does not require strength, the physical work strain is very low.

The ergonomic design of Exact pipe cutters allows avoiding accidents at work and the related absences. Moreover, the risk of developing work strain-related maladies is reduced.

**exact**  
Pipe Cutting System

## PIPE CUTTING

**exact**  
Pipe Cutting System



**Includes:** PipeCut 170 pipe saw, TCT 140 blade, shoulder bag, pipe support (4pc), instructions, hex keys 5 mm & 2 mm, DVD-video.

### EXACT 170 PIPE CUTTING MACHINE

TECHNICAL SPECIFICATIONS	
Motor power	1010 watt
Voltage	220-240 V
Range of use	ø 15 mm - ø 170 mm
Max. pipe wall	6 mm steel / 14 mm plastic
Suitable for	All materials
No-load speed	4000 r/min
Weight	5.7 kg
Blade diameter	140 mm
Mounting bore	62 mm



**Includes:** PipeCut 170E pipe saw, TCT 140 blade, shoulder bag, pipe support (4pc), instructions, hex keys 5 mm & 2 mm, DVD-video

### EXACT 170 E PIPE CUTTING MACHINE

TECHNICAL SPECIFICATIONS	
Motor power	1200 watt
Voltage	220-240 V
Range of use	ø 15 mm - ø 170 mm
Max. pipe wall	8 mm steel / 14 mm plastic
Suitable for	All materials
No-load speed	1600 - 3500 r/min
Weight	5.7 kg
Blade diameter	140 mm
Mounting bore	62 mm



**Includes:** PipeCut 220 Pro pipe saw, TCT 140 blade, shoulder bag, pipe support (4pc), instructions, hex keys 5 mm & 2 mm, DVD-video.

### EXACT 220 PRO PIPE CUTTING MACHINE

TECHNICAL SPECIFICATIONS	
Motor power	1200 watt
Voltage	220-240 V
Range of use	ø 20 mm - ø 220 mm
Max. pipe wall	8 mm steel / 14 mm plastic
Suitable for	All materials
No-load speed	1900 - 2885 r/min
Weight	11.5 kg
Blade diameter	140 mm
Mounting bore	62 mm



**Includes:** PipeCut 280 Pro Series pipe saw, TCT 165 blade, shoulder bag, pipe support x 4, instructions, allen keys 5 mm & 2 mm.

### EXACT 280 PRO PIPE CUTTING MACHINE

TECHNICAL SPECIFICATIONS	
Motor power	2500 watt
Voltage	220-240 V
Range of use	ø 55 mm - ø 280 mm
Max. pipe wall	20 mm steel / 45 mm plastic
Suitable for	All materials
No-load speed	1900 - 2900 r/min
Weight	15.5 kg
Blade diameter	165 mm
Mounting bore	62 mm

CHECK WEBSITE FOR MORE MODELS



**Includes:** PipeCut 360 Pro Series pipe saw, TCT 165 blade, shoulder bag, pipe supports 2 single 1 double, instructions, allen keys 5 mm & 2 mm.

**EXACT 360 PRO PIPE CUTTING MACHINE (+460 PRO)**

TECHNICAL SPECIFICATIONS	
Motor power	2500 watt
Voltage	220-240 V
Range of use	ø 75 mm - ø 360 mm
Max. pipe wall	20 mm steel / 50 mm plastic
Suitable for	All materials
No-load speed	1900 - 2900 r/min
Weight	17.5 kg
Blade diameter	165 mm
Mounting bore	62 mm



**Includes:** PipeCut 170 battery pipe saw, TCT 140 blade, shoulder bag, pipe support (4pc), instructions, hex keys 5 mm & 2 mm, DVD-video

**EXACT 170 BATTERY PIPE CUTTING MACHINE**

TECHNICAL SPECIFICATIONS	
Battery	18 V
Range of use	ø 15 mm - ø 170 mm
Max. pipe wall	6 mm steel / 14 mm plastic
Suitable for	All materials
No-load speed	3500 r/min
Weight	6 kg
Blade diameter	140 mm
Mounting bore	62 mm



**Includes:** PipeCut P 400 battery pipe saw, TCT 140 blade, shoulder bag, pipe support (4pc), instructions, hex keys 5 mm & 2 mm, DVD-video.

**EXACT P 400 BATTERY PIPE CUTTING MACHINE (+ P400 / +P1000)**

TECHNICAL SPECIFICATIONS	
Battery	18 V
Range of use	ø 100 mm - ø 400 mm
Max. pipe wall	25 mm Plastic / 22 mm cut & bevel
Suitable for	Plastic pipes
No-load speed	3500 r/min
Weight	7 kg
Blade diameter	140/150 mm
Mounting bore	62 mm



**Includes:** V1000 pipe saw, Cermet V155 blade, shoulder bag, instructions, hex keys 5 mm & 2 mm, DVD-video.

**EXACT V1000 PIPE CUTTING MACHINE**

TECHNICAL SPECIFICATIONS	
Motor power	1010 watt
Voltage	220-240 V
Range of use	ø 75 mm - ø 1000 mm
Max. pipe wall	1.5 mm Spiral / Seam. 6 mm
Suitable for	Ventilation pipes
No-load speed	4000 r/min
Weight	6 kg
Blade diameter	155 mm
Mounting bore	65 mm

**CHECK WEBSITE FOR MORE MODELS**

## SAWBLADES EXACT MACHINES



### BLADES & DISCS 140 / 165 / 180 / SPECIAL BLADES

ARTICLE NR.	Ø	BORE	KERF	BODY	TEETH	PIPE MATERIAL	SUITABLE WITH
TCT 140	140	62	1.8	1.4	46	Steel, Copper, Plastics	PC 170, 170E, 220E, 280 PS, 360 PS, 460 PS
TCT Z140	140	62	1.8	1.4	38	Steel, Copper, Plastics	PC 170, 170E, 220E, 280 PS, 360 PS, 460 PS, 460 PS, 460 PS
Cermet 140	140	62	1.8	1.4	46	Steel, Stainless Steel, Copper, Plastics	PC 170, 170E, 220E, 280 PS, 360 PS, 460 PS
Cermet 140 Thin	140	62	1.4	1.2	46	Steel, Stainless Steel, Copper, Plastics	PC 170 Battery
Diamond X140	140	62	2.7	1.5	-	Cast Iron, Ductile (Nodular Cast Iron)	PC 170, 170E, 220E, 280 PS, 360 PS, 460 PS
Alu 140	140	62	2.5	1.8	36	Aluminium	PC 170, 170E, 220E, 280 PS, 360 PS, 460 PS
INOX 140	140	62	1.8	1.4	46	Stainless Steel, Acid Proof	PC 220 INOX & 360 INOX
TCT 165	165	62	1.8	1.4	52	Steel, Copper, Plastics	PC 280 PS, 360 PS, 460 PS
Cermet 165	165	62	1.8	1.4	52	Steel, Stainless Steel, copper, plastics	PC 280 PS, 360 PS, 460 PS
Diamond X165	165	62	2.7	1.5	-	Cast Iron, ductile (Nodular Cast iron)	PC 280 PS, 360 PS, 460 PS
Alu 165	165	62	2.5	1.8	42	Aluminium	PC 280 PS, 360 PS, 460 PS
Diamond C+B	165	62	3.1	2	0	Cast Iron, Ductile (Nodular Cast Iron)	C+B 360 PS, C+B AIR 360
ALU 180	180	62	2.7	1.8	46	Steel, Stainless Steel, Copper, Plastics	PC AIR 360, 360 PS, 460 PS
Cermet 180	180	62	2.7	1.8	46	Steel, Stainless Steel	PC AIR 360, 360 PS, 460 PS
Diamond X180	180	62	2.7	1.5	-	Cast Iron	PC AIR 360, 360 PS, 460 PS
CERMET V155	155	65	1.6	1.4	58	Thin wall ventilation pipes	PC V1000
TCT P150	150	62	1.8	1.4	40	Plastics (PE, PP, PVC and similar)	PC P400
Cut+bevel 148	148	62	2/30		40/8	Plastics (PE, PP, PVC and similar)	PC P400, PC P1000
Cut+bevel 190	190					Plastics (PE, PP, PVC and similar)	PC P1000
Cut+bevel diam.	140	62				Cast Iron, Plastics	C+B 170E
Cut+bevel diam.	165	62				Cast Iron, Plastics	C+B 360 PS, C+B 460 PS
Pipebevel tips						Steel, Aluminium, Stainless Steel	PipeBevel 220E, PipeBevel 360E
TCT 190	190					Large diameter plastic pipes	PC P1000
TCT 250	250					Large diameter plastic pipes	PC P1000

BLADES & DISCS 165 are suitable for our former models: Exact PipeCut 280E, 360E, 410E

PLEASE NOTE: PS (Pro Series) models can be mounted with a 140 mm saw blade, but will have limited maximum cutting depth.

# BEVELING MACHINES

For pipe, plate and finishing

The FE PBM range of pipe beveling machines for mechanical weld preparation and orbital welding makes pipe beveling jobs easier to complete on-site or in the workshop. The pipe beveling machine is affixed to the pipe with an inside or outside clamping device. The pipe beveling machine is operated by one worker, who gives a manual feed to the pipe beveling machine with a lever. One cutter is attached to the blade holder.

In general, for the weld preparation of heavy wall pipes the weld edge end has to be beveled in a 0°, 30°, 37.5° outside or j-shape (inside 15°). Most companies use a heavy grinder for this work. This takes a long time, is not precise and creates terrible working conditions for the worker. Dust, vibrations and noise physically harm the worker. Low quality weld preparation reduces the quality of the welding junction and long preparation time increases production costs.

All FE PBM pipe beveling machines are available with an electrical or pneumatic drive. Special pipe beveling tools for a wide range of bevel applications are available. Pipe-end preparation is also necessary for orbital welding, to achieve the best pipe weld edge preparations with outside beveling and inside beveling.



## PIPE BEVELING MACHINES

ALL FE PBM MACHINES COME STANDARD WITH ELECTRIC MOTOR. ON REQUEST WE CAN SUPPLY WITH PNEUMATIC MOTOR.



SUPPLIED IN PVC-CASE

### FE PBM 25 PIPE BEVELING MACHINE

TECHNICAL SPECIFICATIONS	
Driven	Bosch motor
Power supply	220-240 V 50/60Hz
Motor power	850 watt
Clamping range (ID)	16 - 25
Working range ( OD)	1" - (33.4 mm)
Wall thickness max.	< 8 mm
Rotation speed	48 MIN-1
Working weight	8 kg
Shipping weight	16 kg
Packing size	540x410x170 mm



SUPPLIED IN PVC-CASE

### FE PBM 76 PIPE BEVELING MACHINE

TECHNICAL SPECIFICATIONS	
Driven	Bosch motor
Power supply	220-240 V 50/60Hz
Motor power	850 watt
Clamping range (ID)	25 - 76
Working range ( OD)	3" - ( 88.9 mm)
Wall thickness max.	< 15 mm
Rotation speed	48 MIN-1
Working weight	9 kg
Shipping weight	16 kg
Packing size	540x410x170 mm



SUPPLIED IN PVC-CASE

### FE PBM 159 PIPE BEVELING MACHINE

TECHNICAL SPECIFICATIONS	
Driven	Bosch motor
Power supply	220-240 V 50/60Hz
Motor power	1050 watt
Clamping range (ID)	60 - 159
Working range ( OD)	6" - ( 168.28 mm)
Wall thickness max.	< 20 mm
Rotation speed	36 MIN-1
Working weight	17 kg
Shipping weight	31 kg
Packing size	560x550x250 mm



Clamping keys for different pipe diameters



Cutters

## PIPE BEVELING MACHINES

ALL FE PBM MACHINES COME STANDARD WITH ELECTRIC MOTOR. ON REQUEST WE CAN SUPPLY WITH PNEUMATIC MOTOR.



SUPPLIED IN WOODEN-CASE

### FE PBM 210 PIPE BEVELING MACHINE

TECHNICAL SPECIFICATIONS	
Driven	Electric
Power supply	220-240 V 50/60Hz
Motor power	1200 watt
Clamping range (ID)	65 - 210
Working range (OD)	8" - (219.08 mm)
Wall thickness max.	< 20 mm
Rotation speed	24 MIN-1
Working weight	28 kg
Shipping weight	44 kg
Packing size	650x280x250 mm



SUPPLIED IN WOODEN-CASE

### FE PBM 340 PIPE BEVELING MACHINE

TECHNICAL SPECIFICATIONS	
Driven	Electric
Power supply	220-240 V 50/60Hz
Motor power	1500 watt
Clamping range (ID)	145 - 340
Working range (OD)	14" - (355.6 mm)
Wall thickness max.	< 20 mm
Rotation speed	20 MIN-1
Working weight	48 kg
Shipping weight	70 kg
Packing size	830x430x410 mm



SUPPLIED IN WOODEN-CASE

### FE PBM 630 PIPE BEVELING MACHINE

TECHNICAL SPECIFICATIONS	
Motor power	1430 watt
Clamping range (ID)	280 - 600 mm
Working range (OD)	6" - ( 168.28 mm)
Wall thickness max.	15 mm
Pneumatic capacity	2210 watt
Feed length	54 mm
Rotation speed	10 rev/min
Weight	75 kg

## CUTTERS FOR FE PBM INSIDE PIPE BEVELER

CUTTER	ART NO.	DESCRIPTION	
Plain cutter	FECI 7.0001	Plain 0°	
Bevel cutter	FECI 7.0003	Bevel 30°	

CUTTER	ART NO.	DESCRIPTION	
Bevel cutter	FECI 7.0004	bevel 37,5°	
Interior bevel cutter	FECI 7.0002	bevel 15°	

## BEVELING MACHINES



SUPPLIED IN STEELCASE

### FEB 18/2 BEVELING MACHINE

TECHNICAL SPECIFICATIONS	
Motor power	2200 watt
Minimal hole diameter of countersinking	40 mm (1.57")
RPM	1800-5850 rpm
Bevel angle (depending on milling head)	22.5°,30°,37.5°,45°,55°,60°
Rounding edges	R2, R3, R4, R5
Maximum bevel width	18 mm
Weight	10 kg (22 lbs)
Power supply	220-240 V / 50-60 Hz or 110-120V / 60Hz
More info	Supplied without Head.



SUPPLIED IN STEELCASE

### FEB 21 S STAINLESS STEEL BEVELING MACHINE

TECHNICAL SPECIFICATIONS	
Motor power	1600 watt
RPM	1360 - 1630 min-1
Max. Bevel	21 mm
Angle Setting	0° - 60° stepless variable
Weight	23 kg
More info	Intergrated head with 10 square tct inserts



SUPPLIED IN STEELCASE

### FEB 25 BEVELING MACHINE

TECHNICAL SPECIFICATIONS	
Motor power	1100 watt
RPM	2850 min-1
Angle Setting	15° - 60° variable
Safety	Automatic overload cutout
Maximum bevel width	15 mm
Weight	22 kg
Tools	Arbor milling cutter, double-row with 10 sintered carbide reversible cuttingplates



SUPPLIED IN STEELCASE



### FEB 20 PLUS PORTABLE BEVELING MACHINE

TECHNICAL SPECIFICATIONS	
Power supply	1600 watt
RPM	2780 - 3340 min-1
Max. Bevel	21 mm
Angle Setting	15° - 60° stepless variable
Weight	22 kg
More info	Two milling heads with 10 square cutting inserts



**FEB 30/45/R25 BEVELING MACHINE**



TECHNICAL SPECIFICATIONS	
Motor power	1500 watt
Speed	6000 min-1
Max. bevel width	0-5 mm FEB 30   0-6 mm FEB45, R25
Angle Setting	30° FEB 30   45° FEB45   2.5 R25
Weight	4.6 kg (10.14 Lbs)
Other	Cutting plate holders are interchangeable. Thermo protection.

FEB 30 
 FEB 45 
 FEB R25 



**FEB 530/ 545 BEVELING MACHINE**



TECHNICAL SPECIFICATIONS	
Motor power	1800 watt
Speed	1850 - 3350 min-1
Max. bevel width	0-12 mm
Angle Setting	30° / 45°
Weight	9,3 KG (20,04 Lbs)
Other	Cutting plate holders are interchangeable. Thermo protection.

FEB 530 
 FEB 545 



**FEB 630/ 645 BEVELING MACHINE**

TECHNICAL SPECIFICATIONS	
Motor power	2300 watt
Speed	1600 - 3000 min-1
Max. bevel width	0-15 mm
Angle Setting	30° / 45°
Weight	10,2 KG (21,98 Lbs)
Other	Cutting plate holders are interchangeable. Thermo protection.

FEB 630 
 FEB 645 

**CUTTING PLATES AND HOLDERS FOR FEB 30, FEB 45 AND FEB R25**  
 HIGH-QUALITY HARDMETAL CUTTING PLATES FOR MOST APPLICATIONS



ARTICLE NR.	CONNECTION
FEC12.001	Cutting plate FEB 30 – FEB 45
FEC12.002	Cutting plate FEB R25 ( Radius 2,5)
FEC10.0001	Cutting plate FEB 530/545/630/645
FECH2.0001	Cutting plate HOLDER FEB 30
FECH2.0002	Cutting plate HOLDER FEB 45
FECH2.0003	Cutting plate HOLDER R25

## BEVELING MACHINES



### NKO BEVELING MACHINES

NKO Machines is a European manufacturer of the world's most advanced and innovative beveling technology. A prominent manufacturer of premium quality high efficient beveling systems, NKO bevellers are known for their premium quality and advourable prices. With many years of combined experience in welding and steel industry, NKO Machines provide cost effective solutions for weld preparation that will improve your manufacturing process.



#### UZ 12 FULL AUTOMATIC BEVELING MACHINE

TECHNICAL SPECIFICATIONS	
Max. width of bevel	12 mm
Bevel angle	30° - 50° variable
Thickness material	3 - 35 mm
Motor	400 watt
RPM	4.6 kg (10.14 Lbs)
Speed	180 cm / min
Weight	30 kg
Manipulator	Optional

UZ12 ULTRALIGHT creates welding-ready bevels on linear plates of any shearable material, including iron, steel (up to 60kg/mm<sup>2</sup> or 85,000lbs/in<sup>2</sup>), stainless steel, brass, copper and aluminum. It cuts bevels from 3 to 35mm in thickness, with a minimum plate width of 60 mm and minimum plate length of 60mm.



#### UZ 50 FULL AUTOMATIC BEVELING MACHINE

TECHNICAL SPECIFICATIONS	
Max. width of bevel	62 mm
Bevel angle	15° - 60° variable
Thickness material	7 - 70 mm
Motor milling	4000 watt / 400V / 3 phases/ 50 Hz
Motor automatic feeding	2 engine 120 watt
Speed	183 cm / min
Weight	175 kg
Manipulator	Standard
Working table	Optional

The beveler UZ 50 Triumph - very efficient, unique double sided beveling machine for steel, stainless steel, HARDOX, DOMEX and aluminium (max. width of bevel 62 mm) 3 BEVELERS IN ONE, fully automatic.



#### B15 AIR BEVELING MACHINE

TECHNICAL SPECIFICATIONS	
Power	2984 Watt
Air pressure/ consumption	15° - 60° variable
RPM	6000 min
Bevel width	0 -15 mm
Bevel angle	Optional 30°, 37,5°, 45°, 50° or 60°
Cutting head	Optional
Weight	7.5 kg

Pneumatic Hand Beveler with huge power for straight edges, contours, boreholes, radius. The beveler is designed and produced in Europe and brings a new high ergonomics design and huge power for every day beveling. Aluminum alloy body engine, Hardox support plate, milling head and inserts designed especially for hand beveler.

BEVELING MACHINES



**B2 AIR BEVELING MACHINE**

TECHNICAL SPECIFICATIONS	
Chamfering angle	45°
Chamfering width (hypotenuse)	2 mm / 0.08 i
Rounding radius	R 1,5 mm / 0.06
Speed	23,000 rpm.
Feed	Manual
Air consumption	320 l/min
Dimensions	112 x 60 x 48 mm
Weight	400 g / 0.88 Lbs
Number of cutting tips	3 pcs

Designed for deburring and rounding edges of parts and products made of steel, stainless steel, aluminum and other materials. Suitable for machining holes from the internal diameter of 6.8 mm / 0.24 in.



**B2 AIR X BEVELING MACHINE**

TECHNICAL SPECIFICATIONS	
Chamfering angle	45°
Chamfering width (hypotenuse)	2 mm / 0.08 i
Speed	23,000 rpm.
Feed	Manual
Air consumption	320 l/min
Dimensions	112 x 60 x 48 mm
Weight	400 g / 0.88 Lbs
Number of cutting tips	3 pcs

Designed for deburring and rounding edges of parts and products made of steel, stainless steel, aluminum and other materials. Suitable for machining holes from the internal diameter of 6.8 mm / 0.24 in.



**FE POWERTOOLS BEVELING MACHINES  
GIVE YOU WELD PREPARATION THAT  
WILL IMPROVE YOUR MANUFACTURING  
PROCES.**

# LUBRICANT

with the Fe lubricant program you get the best performance

## **HIGH-PERFORMANCE LUBRICANTS AND CUTTING OILS FROM FE POWERTOOLS ARE AVAILABLE FOR ALL APPLICATIONS IN THE METALWORKING INDUSTRY.**

FCO cutting oils and FEHS hand sprays are suitable for special work conditions and for all kinds of materials. The FCO oil is specially produced for Fe Powertools. This chlorine-free cutting oil allows for much better performance. Your cutting and threading will be much faster and easier, creating a better end result. The lifespan of your cutting tool will increase enormously. Professional workers only use FCO lubricants and cutting oils.

### **FE Lubricants and cutting oils**

Fe Powertools lubricants give you better results and extend the lifespan of your tools. High performance is guaranteed if you use the right FCO lubricants. Oil is not only necessary as a coolant, but it is also important for optimizing the cutting capacity of your tools. Therefore we offer the best additives to ensure your tools will cool down and cut more easily. For cutting tough materials, we also offer cutting paste FECP1. Moreover, if you have to cut above your head, we advise using cutting paste because it sticks to the tool and will not drip down. Another advantage of the cutting paste is that no grease is left after cutting, making the material easy to clean.



LUBRICANT & CUTTING OIL



CUTTING OIL AND CUTTING PASTE

ARTICLE NR.	TYPE	QUANTITY
FCO 1.5	Cutting Oil	5 L
FCO 2.5	Cutting Oil	5 L (1:20 Dilutable)
FCO 1.60	Cutting Oil	60 L
FCO 1.210	Cutting Oil	210 L
FCO 3.5	Cutting Oil	5 L Mist
FE CP 1	Cutting Oil	1000 grs
FEHS 001	Cutting Oil	400 ml (12 pcs)

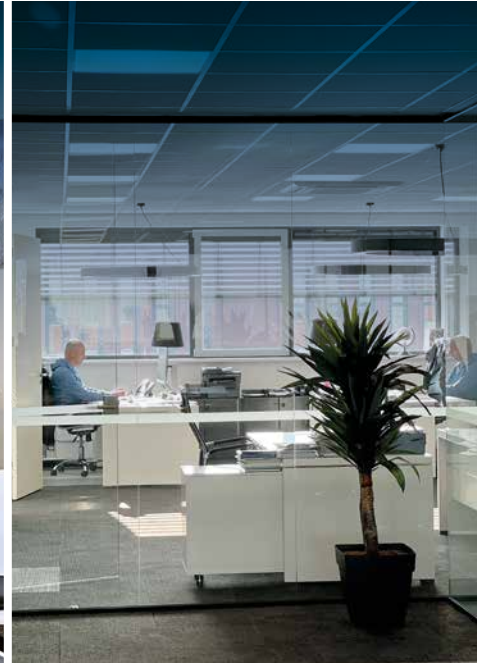



**EC declaration of Conformity**

In accordance with Machine Directive 2006/42/EC, appendix II 1 A. The following Fe Powertools machines conforms tot he relevant guidelines.

**Magnetic drilling machine:** FE 30, FE 32X, FE 36 SX, FE 36 X, FE 35 AUT, FE 50 X, FE 50 RLX, FE 60 RLX, FE 100 RLX, FE 150 RLX, FE 35 DC, FE 50 DC, FE 40 AIR and FE Rail 36.

**Beveling machines:** FE PBM 25, FE PBM 76, FE PBM 159, FE PBM 210, FE PBM 340, FE PBM 630, FEB 18/2, FEB 20, FEB 25, FEB 30, FEB 45, FEB R25, FEB 530/545, FEB 630/645, UZ 12, UZ 50, B15 Air, B2 AIR, B 2 Air X

The following harmonised standards were applied in whole or in part:

- DIN EN ISO 12100:2011-03
- DIN EN 62841-1:2016-07

Authorised Company for compiling the technical documentation:

**FE Powertools BV**

Full technical documentation is available. The operating instructions associated with the product is available.

It is required that the product is only operated as intended. Information on operating as intended can be obtained from the technical documentation.

**Company:**  
Fe Powertools BV

**Managing Director:**  
Mark Korsten



Jac. P. Thijsseweg 16  
2408ER Alphen aan den Rijn  
The Netherlands



**FEpowerTools®**

**Fe Powertools bv**

Jac. P. Thijsseweg 16 | 2408 ER Alphen aan den Rijn | The Netherlands  
T +31 (0)172 47 47 27 | E info@fepowertools.com | W www.kernboor.nl (NL)

**[www.fepowertools.com](http://www.fepowertools.com)**