

INSTRUCTION MANUAL

HANDY PNEUMATIC SANDER

Please read this manual carefully before you attempt to use your tool so that you may use it properly and safely.

FREE SANDER Model FS-100C, FS-50A PROFESSIONAL TOOL



FS-100C



FS-50A

Specifications

Model	FS-100C	FS-50A
Maximum Operating Pressure	0.6 MPa	0.6 MPa
Air Consumption (No Load)	0.2 m ³ /min	0.14 m ³ /min
Rated Speed (No Load)	20,000 min ⁻¹	15,000 min ⁻¹
Orbit Diameter	1.5 mm (1/6")	1.2 mm (3/64")
Pad Size	100 mm x 110 mm (4" x 4-3/8")	75 mm x 82 mm (2-15/16" x 3-7/32")
Abrasive Paper Size	114 mm x 140 mm (4-1/2" x 5-1/2")	70 mm x 114 mm (2-3/4" x 4-1/2")
Mass (Weight)	0.5 kg	0.5 kg
Sound Pressure Level	82 dB(A)	76 dB(A)
Sound Power Level	93 dB(A)	87 dB(A)
Vibration Level [Uncertainty K]	≤ 2.5 m/s ² (2.4 m/s ² [0.73 m/s ²])	2.7 m/s ² [0.76 m/s ²]
Thread Size of Air Inlet	Rc1/8	Rc1/8

Due to continuous product development/improvement the specifications and configurations in this document are subject to change without prior notice.



Manufactured by :

NITTO KOHKI Co., Ltd.

2-9-4, Nakaikegami, Ohta-ku,
Tokyo, 146-8555, Japan

Tel : (81)-3-3755-1111

Fax : (81)-3-3753-8791

E-mail : overseas@nitto-kohki.co.jp

URL : www.nitto-kohki.co.jp

Keep the manual handy – so you can use it whenever necessary.

Original Instructions

Thank you very much for your purchase of this **Nitto Kohki products**.





Before using your tool, please read this manual carefully so that you may use it properly to get the most out of it.

Please keep the manual handy - so you can use it whenever necessary.



- **English** : Please ask your dealer or distributor for instruction manual in local language(s).
- **German** : Bitte fragen Sie Ihren Händler nach eine Betriebsanleitung in Landessprache.
- **French** : S'il vous plait, veuillez demandez á votre fournisseur de manuel instruction en langue locale.
- **Spanish** : Por favor, contacte con su distribuidor para el manual de instrucciones en español.
- **Portuguese** : Por favor pessa ao seu agente ou distribuidor o manual de instruções em linguagem local.
- **Italian** : Per Manuale Istruzioni in lingua locale Vi preghiamo di rivolgervi al rivenditore o distributore.
- **Dutch** : Vraag uw handelaar om een nederladstalige gebruiksaanwijzing.
- **Swedish** : Be er lokala Åtreförsäljare eller distributör om manualer på svenska.
- **Danish** : Venligst henvend Dem til den danske distributør for instructions manualer.
- **Polish** : Proszę pytać swojego dealera lub dystrybutora o instrukcje obsługi w języku localnym.
- **中文** : 請向當地供應商或經銷商詢問中文使用說明書

CONTENTS	page
IMPORTANT SAFETY INSTRUCTIONS	2
GENERAL: TOOLS	2
GENERAL: PNEUMATIC TOOLS	3
INSTRUCTIONS FOR THIS TOOL	4
1. USAGE	4
2. CHECK THE CONTENTS OF THE PACKAGE	4
3. AIR SUPPLY	4
4. PREPARATIONS	4
5. ATTACH ABRASIVE PAPER	5
6. HOW TO OPERATE THE TOOL.....	5
7. REPLACING RUBBER SUPPORTS	6
8. STORAGE	7
9. ORDERING SERVICE PARTS	7
10. OPTIONAL PARTS	7
11. EXPLODED DIAGRAM : FS-100C	8
12. EXPLODED DIAGRAM : FS-50A	9

PICTOGRAM

-  Warning: It might be dangerous to operate the tool if the instructions supplied are not followed.
-  Using this tool improperly could result in serious injury. Read the instruction manual before using.
-  Always wear suitable eye protection.
-  Always wear suitable hearing protection.
-  Always wear respiratory protective equipment (PPE).

The following Safety notations are used throughout the manual to highlight safety precautions for the user and for the tool.

 WARNING:	Indicates a potentially hazardous situation which, if not avoided by following the instructions given, could result in death or serious injury.
 CAUTION:	Indicates a potentially hazardous situation which, if not avoided by following the instructions given, could result in injury or material damage.

Please note, however, that failure to observe safety precautions under the “Caution” category could result in a serious occurrence depending on the situation: please observe all safety precautions in the manual.

Caution: Important precautions for tool setup, operation and maintenance.

IMPORTANT SAFETY INSTRUCTIONS

When using the tool, please observe the safety precautions below to prevent possible accident or injury.

GENERAL: TOOLS

WARNING

TO OPERATORS

- **Wear proper clothing for the type of work being done.**

Take care so that clothing, ties, hair etc. will not become entangled with the moving parts. If items become entangled it will cause the operator to be pulled towards the tool and lead to possible cause of accident or injury.

- **Always wear suitable eye protection.**
Remember, regular glasses are not safety glasses. The lenses are only shock resistant, which will not give you sufficient eye protection you may need in your working environment.
- **Always wear suitable hearing protection.**
- **Wear respiratory protective equipment (PPE).**
Wear respiratory protective equipment (PPE) when working in an environment where dust particles are generated in operation.
- **Avoid working posture that is too stressful.**
Always ensure a firm footing and well balanced posture.
- **Do not operate the tool if you are too tired.**
- **Never touch any moving parts of the tool when running.**

ABOUT WORK AREA

- **Keep the work area clean.**
Cluttered work areas (e.g. workbench) invite accidents.
- **Carefully select the work area.**
Do not expose tool to rain.
Do not use tool in a wet or soaked area.
See that the work area is adequately illuminated.
- **Never work near inflammable liquid or in a potentially explosive atmosphere.**
- **Keep children away from the work area.**
Keep children and unauthorized people away from the work area to avoid accident or injury.

BEFORE OPERATION

- **Inspect tool before use.**
Before using, check that screws are securely tightened, that any protective cover or guard is securely in place, other parts are free from damage and that the tool runs as it should.
Check that moving parts are properly adjusted for positioning and tightened, that parts are free from damage and properly mounted, and that all other parts are in good condition for normal operation.
Should you find any damage to the protective cover or other part, replace it in accordance with the Operation Manual. If there are no instructions in the Manual, please contact the sales agent through which you have purchased your tool or an authorized dealer near you for repair.
Likewise, if a switch failure occurs, contact sales agent through which you have purchased your tool or an authorized dealer near you for repair.
Do not use the tool if it does not start or stop with the start/stop switch.
- **Securely mount cutter**
An improperly mounted cutter may fly out, causing possible damage to the tool or injury to the operator.
- **Always remove spanner, wrench, etc., once adjustment has been made with them.**
- **Use a tool appropriate for the application.**
Avoid heavy-duty application that is beyond the capacity of tool.
- **Do not use the tool for purposes other than what it is designed for.**
- **Do not abuse tool.**
Use tool in accordance with the specifications: you'll get the most out of it while ensuring safety.
- **Securely fasten workpiece in place.**
Use a vice or clamp to securely fasten the workpiece in place. It is much safer this way than holding it in your hand, allowing you to operate the tool with both hands.

ABOUT HANDLING

- **How to store tool.**
When the tool is not used, store it in a dry area and out of reach of children.
- **How to carry tool.**
Do not touch the start switch while the tool is being carried.
- **Do not leave the tool unattended while it is running.**
Turn off the start switch and disconnect the tool from power source. Do not leave the work area until the tool comes to a complete stop.

MAINTENANCE/SERVICE

- **Do not take apart or modify tool.**
Disassembly or modification carried out without the supervision of a qualified or authorized service engineer could result in an accident or injury.
- **Inspect cutting tool and accessories, etc.**
Always check to see that cutting tool and accessories, etc. are in good operating condition without damage or deterioration before you mount them on the tool. Should you find any damage to an accessory or part, please contact sales agent through which you have purchased your tool or an authorized dealer near you for repair.
- **Check parts for damage.**
When you have found damage to accessory or other part, carefully check the damaged part to determine the extent of influence it has upon the functions of the tool – that is, determine whether it can still perform its normal functions.
Check to see that the linkage of the moving parts is OK, that all parts are OK without damage, that they are properly mounted, and that the tool functions normally. Should you find any damage to an accessory or part that may hamper proper functioning of the tool, please contact sales agent through which you have purchased your tool or an authorized dealer near you for repair.
- **Have your tool repaired at an authorized Nitto Service Center.**
For repair or parts replacement, please contact the sales agent through which you have purchased your tool or an authorized dealer near you.
- **Use only Nitto genuine parts.**
Use of improper parts may result in serious accident. To obtain a Nitto genuine part, consult this Manual or contact the sales agent from which you have purchased your tool directly.
- **Do not detach label or nameplate from tool.**
When a label/nameplate gets damaged, worn or becomes missing, contact the sales agent through which you have purchased your tool or Nitto Kohki Co. Ltd, directly for a replacement.

DISPOSAL

- When a tool is taken permanently out of service, it is advised that the tool is disassembled, degreased and parts separated by material and recycled locally in the appropriate manner.

GENERAL: PNEUMATIC TOOLS

WARNING

- **Use appropriate air pressure.**
Excessively high air pressure will increase the tool number of revolutions or strokes causing not only potential premature failure/breakage but could also lead to an unexpected accident or injury.
- **Connect tool to air supply line.**
There are various types of pipes running in a factory in addition to the pneumatic line (such as oxygen, nitrogen, gas and water). For this reason, always ensure that you are connecting to the pneumatic line.
- **Start tool properly.**
Turn the start switch OFF before connecting to the air supply line.
- **Always disconnect the tool from the air supply line before putting on/taking off any accessory and prior to carrying out any maintenance work.**
- **Avoid exposure to exhaust air.**
Pneumatic tool exhaust air contains oil and contaminated moisture. Make sure the exhaust air is not directed towards your face or anyone else within the work area.
- **Keep tool off electricity.**
This pneumatic tool is not electrically insulated. To avoid a potential electric shock do not use where there is a possibility of coming into contact with live electricity.

CAUTION

- **Handle tool carefully.**
Abusive use of tool could invite failure or accident. Do not throw, drop or shock the tool.
- **Handle connecting hose carefully.**
Do not carry the tool by the air hose. Do not pull the air hose to disconnect.

INSTRUCTIONS FOR THIS TOOL

About Your Tool

WARNING

- **Wear protective glasses and a dustproof mask**
Operation generates chips and dust particles, etc. which may cause eye and/or respiratory injury. Always use PPE (Personal Protective Equipment) for eye and respiratory protection.
- **Always turn off the air supply and disconnect the air supply hose beforehand whenever replacing Abrasive Papers.**
- **Be sure to keep hands clear of moving parts.**
- **Air pressure at the sander inlet must not exceed 0.6 MPa.**
- **Always replace damaged, bent or severely worn Pads.**
Do not use a Pad that has been subjected to an Abrasive Paper failure.
- **Avoid grinding at pad edge or banging pad edge against work material or other object, as this can shorten tool life.**

1. USAGE

This tool is for sanding workpieces using Abrasive Paper.

2. CHECK THE CONTENTS OF THE PACKAGE

Check the contents and make sure that the tool does not have any damage which may have occurred during transportation. The contents should correspond to the list as follows. In case of damage/missing parts, please contact the sales agent from whom you purchased the tool.

FS-100C

Package Contents	Qty	Check
FREE SANDER FS-100C	1set	
Air Hose H Ass'y	1set	
Bushing R1/4 x NPT1/4	1	
Abrasive Paper #180	5	
Abrasive Paper #240	5	
Instruction Manual	1	
Declaration of Conformity	1	
Caution for Use	1	

FS-50A

Package Contents	Qty	Check
FREE SANDER FS-50A	1set	
Air Hose H Ass'y	1set	
Bushing R1/4 x NPT1/4	1	
Abrasive Paper #180	5	
Abrasive Paper #240	5	
Instruction Manual	1	
Declaration of Conformity	1	
Caution for Use	1	

3. AIR SUPPLY

3-1. Air Pressure

Adjust air pressure with the air regulator to the appropriate level for the pneumatic tool used.

Air pressure that is too low will stop the tool from operating at full capacity.

Air pressure that is too high may cause damage to the tool.

3-2. Air Line (Fig.1)

Use a 9.5 mm (3/8") I. D. connecting hose between the compressor and the tool.

Drained water, etc., if flown into the tool, could cause tool failure. Install an air filter between the compressor and the tool.

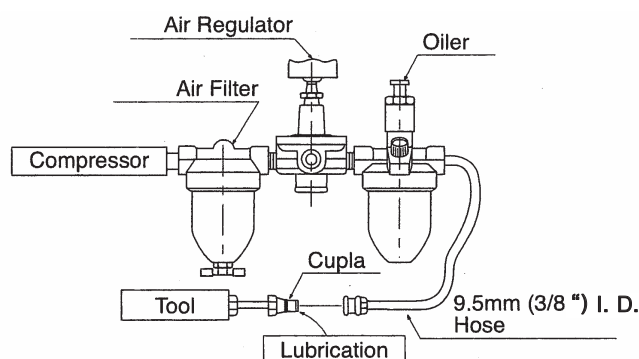

Fig. 1

3-3. Lubrication

Install an oiler between the compressor and the tool. Use the machine oil ISO VG-10. Failure to lubricate as required may result in damage to the tool. Use of oil that is too thick will reduce the performance of the tool.

4. PREPARATIONS

4-1. Thread Size of Hose Fitting

The product comes with a metal fitting with Rc(metric) thread. Connect the Bushing R thread x NPT thread included as standard accessories, if you would like to have American NPT thread instead.

5. ATTACH ABRASIVE PAPER

WARNING

Always turn off the air supply and disconnect the air supply hose beforehand whenever replacing Abrasive Papers.

5-1. Abrasive Paper

Cut standard size paper (9" x 11") into 4 pieces for Model FS-100C and into 8 pieces for Model FS-50A, as shown in Fig.2. For dry sanding, use an open cost type Abrasive Paper with silicon carbide or aluminum oxide abrasive grains to prevent clogging, improve grinding efficiency, and prolong the life of the paper.

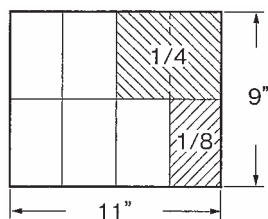

Fig. 2

5-2. Attach Abrasive Paper

Raise the circular knob at the end of the Clamp Spring (2 points), pull to the side, and push it down. The paper clamp will then open, push in Abrasive Paper at this point, raise the circular knob and insert the Clamp Spring inside the Clamp Stopper. This completes fitting the Abrasive Paper. Refer to Fig.3 and Fig.4. Install Abrasive Paper tightly. If both sides are not clamped completely (Fig.5), cutting and sanding power will drop. Compare Fig.4 and Fig.5. Notice how in the incorrectly clamed figure, the cutting surface of the Abrasive Paper does not come in contact with the Rubber Pad.

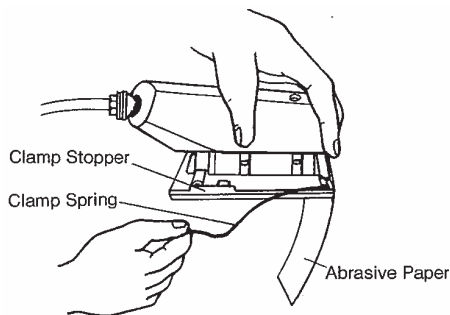

Fig. 3

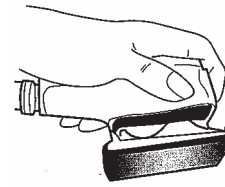

Fig. 4

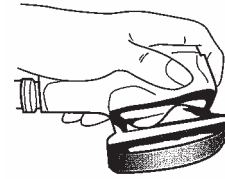

Fig. 5

5-3. In Case of Using Double-Sided Adhesive Tape

Attach double-sided adhesive tape to the sponge part then attach the Abrasive Paper to the tape.

5-4. In Case of Using Spray Adhesive

Spray the Abrasive Paper with adhesive then attach it to the sponge. Since the Abrasive Paper must be removed after it has been used. Avoid using permanent adhesive. Paper adhesives are available.

6. HOW TO OPERATE THE TOOL

6-1. Start and Stop

(1) FS-100C (Fig.6)

To start, press the Trigger until it is locked. Hold the Trigger in this position. To stop, press the Cancel Switch and return the Trigger to its original position.

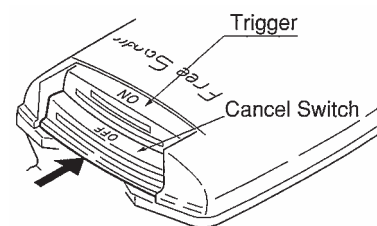

Fig. 6

(2) FS-50A (Fig.7)

To start, push the Trigger all the way towards the body. To stop, pull the Trigger all the way out away from the body. Removing

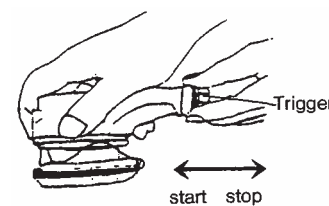

Fig. 7

6-2. Sanding Pressure

Sanding pressure for FS-100C is 20 to 50 N and for FS-50A is 10 to 30 N. Applying excessive force will lower sanding efficiency. For flat work, adjust pressure so force is applied evenly to the entire surface of the Rubber Pad. Uneven pressure will result in an irregular surface.

7. REPLACING RUBBER SUPPORTS

WARNING

Always turn off the air supply and disconnect the air supply hose beforehand whenever replacing Rubber Supports.

7-1. FS-100C

Disassembly Sequence

1) Place the Trigger at OFF, loosen 4 screws (Cross Pan Head Screw with Spring Lock Washer M4 x 10) and remove the Rubber Pad. Loosen 4 nuts of the Rubber Support and remove the Base Plate.

NOTE: Do not remove the air tube.

2) Loosen 4 screws (Cross Recessed Pan Head Tapping Screw M4 x 20) and remove the Housing Cover. (Fig. 8) Trigger and the Cancel Switch can be also taken off same time.

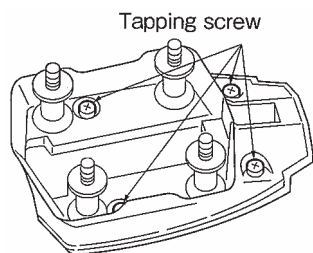

Fig. 8

3) Loosen 4 nuts of the Rubber Support and take out 4 Rubber Supports from the Housing. Now the disassembly is completed. (Fig.9)

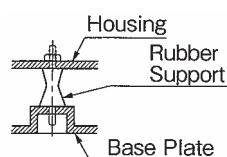

Fig. 9

Assembly Sequence

1) Fix 4 Rubber Supports to the Housing with the nuts. Place the Trigger and the Cancel Switch and spring 0.45 x 3.1 x 17 on the Housing, and mount the

Housing Cover on them, and tighten 4 screws (Cross Recessed Pan Head Tapping Screw M4 x 20).

2) Fix the Base Plate to the Rubber Supports with 4 nuts, taking care to prevent the Rubber Support from being twisted.

NOTE: If the Rubber Support is installed, being twisted, the Rubber Support will be quickly damaged. (Fig.9)

3) Thereafter, reassemble in the reverse of disassembly.

NOTE: If the screws are not tightened securely, they will become loose due to vibration, leading to parts damage. Therefore, tighten them sufficiently.

7-2. FS-50A

Disassembly Sequence

1) Loosen 4 screws (Cross Recessed Pan Head Screw with Spring Lock Washer M4 x 8) and remove the Rubber Pad. (Fig.10)

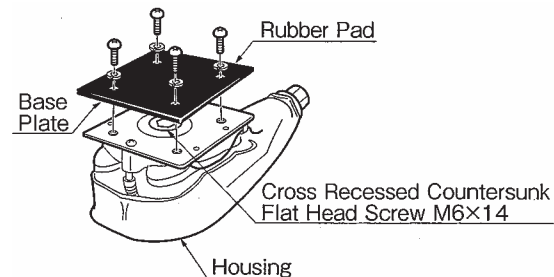

Fig. 10

2) Loosen Cross Recessed Countersunk Flat Head Screw M6 x 14 of the Base Plate and remove the Base Plate from the End Plate. (Fig.10)

NOTE: Do not remove the air tube.

3) Loosen the screws at both sides of the Rubber Support and remove the Rubber Support. Now the disassembly is completed. (Fig.11)

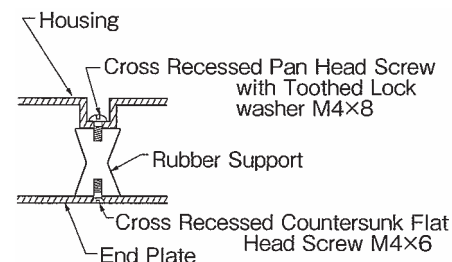

Fig. 11

Assembly Sequence

First, install the Rubber Support to the Housing by screws (Cross Recessed Pan Head Screw with Toothed Lock Washer M4 x 8). Next, fit the End Plate by screws (Cross Recessed Countersunk Flat Head Screw M4 x 6), grasping lightly the bottom of the Rubber Support with pliers, etc. and taking care to prevent the Rubber Support from being twisted.

8. STORAGE

CAUTION

When tool is not used, store it out of reach of children.

Avoid storing the tool in a location subject to high humidity. If the tool is left as it is used, residual moisture on the inside can cause rusting. Before storing, and after operation, oil the tool at the air inlet with machine oil ISO VG-10 and run it for a short time.

9. ORDERING SERVICE PARTS

For further operational and handling information or for replacement of parts and components, contact the company from whom you purchased the tool or an authorized dealer.

In ordering parts and components give each part number, part name and quantity required.

Use only NITTO genuine parts.

10. OPTIONAL PARTS

In addition to standard accessory parts, the following parts are available for your applications and needs.

FS-100C

Part No.	Description	Qty
TA9A367	Rubber Pad A'ssy	1set
TA91474	Round Pad A'ssy	1set
TA9A265	Abrasive Paper #100	200 pcs
TA9A266	Abrasive Paper #120	200 pcs
TA9A267	Abrasive Paper #150	200 pcs
TA9A268	Abrasive Paper #180	200 pcs
TA9A269	Abrasive Paper #240	200 pcs
TA9A270	Abrasive Paper #280	200 pcs
TA9A271	Abrasive Paper #320	200 pcs
TB02240	Dust Collector A'ssy	1set

FS-50A

Part No.	Description	Qty
TA99828	Rubber Pad A'ssy	1set
TB02235	Dust Collector A'ssy	1set

11. EXPLODED DIAGRAM : FS-100C

⚠ WARNING

This diagram is for your reference only. Do not attempt to service or repair the Tool. Do not take the Tool apart. Contact an authorized Nitto dealer for all service and repair of the Tool. Improper service and repair can cause accidents and service injuries. Never attempt to modify the Tool. Never attempt service or repair the Tool yourself.

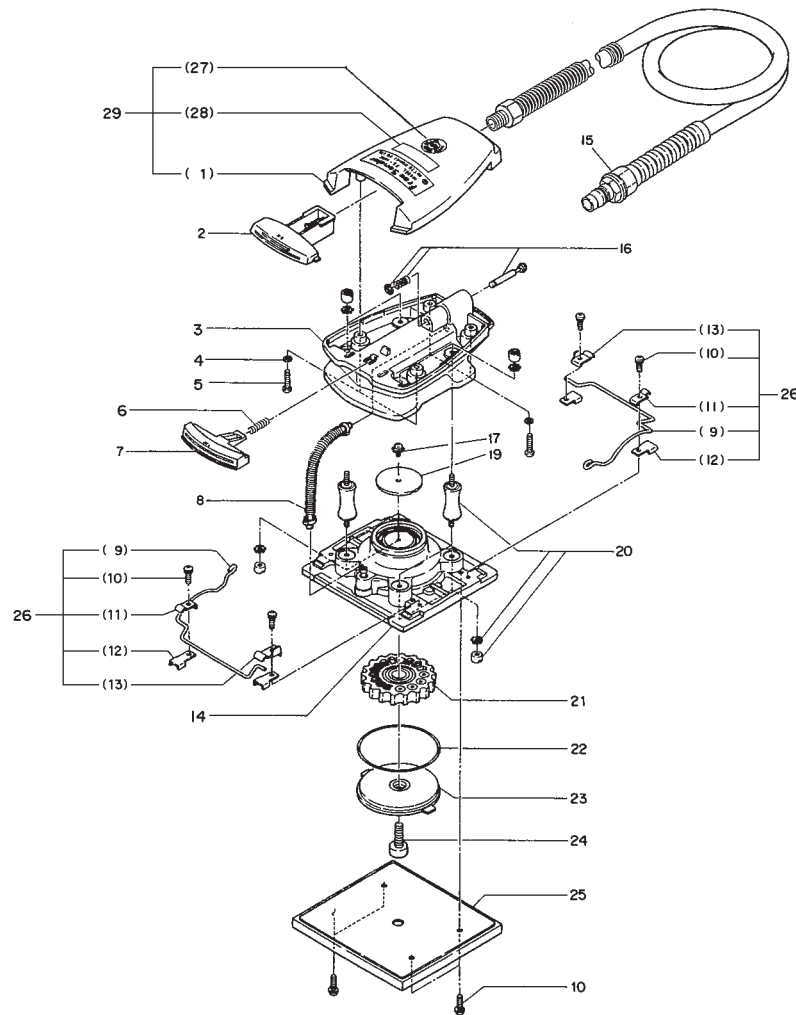

The part numbers with () are included in the Ass'y parts written above them.

No.	Part No.	Description	Qty	Price
29	TB08683	Housing Cover Ass'y	1set	
1	(TP15371)	Housing Cover	1	
27	(TP04218)	Label NITTO	1	
28	(TQ12752)	Warning Label CE Mark	1	
2	TP15374	Trigger	1	
3	TA99365	Housing Sub Ass'y	1set	
4	TP04234	Spring Lock Washer M4	4	
5	TPI 4488	Cross Recessed Pan Head Tapping screw 4 x 20	4	
6	TP15376	Spring 0.45 x 3.1 x 17	1	
7	TPI 5375	Cancel Switch	1	
8	TA91647	Tube Ass'y	1set	
26	TA99971	CLamp Ass'y	2set	
9	(TP10870)	Clamp Spring	2	
10	(TP11245)	Cross Recessed Pan Head Screw 4x10	8	
11	(TP10872)	Clamp Stopper B	2	
12	(TP17901)	Clamp Stopper C	4	
13	(TP10871)	Clamp Stopper A	2	
14	TA9A372	Base Plate Sub Ass'y	1set	
16	TA99364	Throttle Valve Ass'y	1set	

No.	Part No.	Description	Qty	Price
17	TA91575	Cross Recessed Pan Head Screw 4 x 8 Ass'y	1set	
19	TP16951	Filter	1	
20	TA96330	Rubber Support Ass'y	4set	
21	TA9A369	Turbine Ass'y	1set	
22	TP03790	O Ring S-56	1	
23	TA9A371	End Cap Ass'y	1set	
24	TP01945	Hex. Socket Head Cap Screw 5 x 12	1	
25	TA9A367	Rubber Pad Ass'y	1set	

ACCESSORIES

No.	Part No.	Description	Qty	Price
15	TB08077	Air Hose H Ass'y	1set	
	TP02236	Bushing R 1/4 x NPT 1/4	1	
		Abrasive paper # 180	5	
		Abrasive paper # 240	5	
	TQ12753	Instruction Manual	1	
	TQ12754	Declaration of Conformity	1	

12. EXPLODED DIAGRAM : FS-50A

WARNING

This diagram is for your reference only. Do not attempt to service or repair the Tool. Do not take the Tool apart. Contact an authorized Nitto dealer for all service and repair of the Tool. Improper service and repair can cause accidents and service injuries. Never attempt to modify the Tool. Never attempt service or repair the Tool yourself.

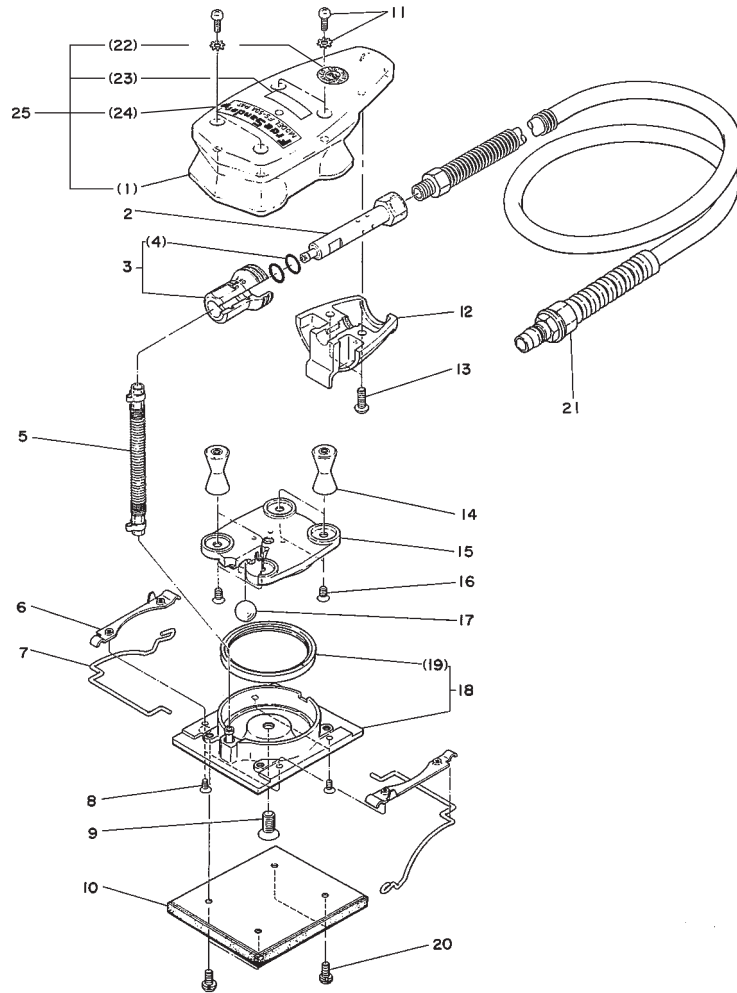

The part numbers with () are included in the Ass'y parts written above them.

No.	Part No.	Description	Qty	Price
25	TB08684	Housing Sub Ass'y	1set	
1	(TP05700)	Housing	1	
22	(TP04218)	Label NITTO	1	
23	(TQ12752)	Warning Label CE Mark	1	
24	(TP05745)	Name Plate	1	
2	TP05698	Valve Nipple	1	
3	TA97589	Trigger Ass'y	1set	
4	(TP1200)	ORingP - 10	2	
5	TA91647	Tube Ass'y	1set	
6	TP05708	Clamp Stopper	2	
7	TP05707	Clamp Spring	2	
8	TQI 725	Hex. Socket Countersunk Head Screw 3 x 6	4	
9	TP04226	Cross Recessed Countersunk Flat Head Screw 6 x 14	1	
10	TA99828	Rubber Pad Ass'y	1set	
11	TA91575	Cross Recessed Pan Head Screw 4x8 Ass'y	4sets	
12	TP05701	Housing Cap	1	
13	TP04217	Cross Recessed Raised Countersunk Head Screw 4 x 10	2	

No.	Part No.	Description	Qty	Price
14	TA91 465	Rubber Support Ass'y	4sets	
15	TP05705	End Plate	1	
16	TP0571 2	Cross Recessed Countersunk Flat Head Screw 4 x 6	4	
17	TP05706	Steel Ball (15/32")	1	
18	TA92337	Cylinder Sub Ass'y	1set	
19	(TP05703)	Cylinder	1	
20	TP06290	Cross Recessed Pan Head Screw with Spring Lock Washer 4 x 8	4	

ACCESSORIES

No.	Part No.	Description	Qty	Price
21	TB08077	Air Hose H Ass'y	1set	
	TP02236	Bushing R 1/4 x NPT 1/4	1	
		Abrasive paper # 180	5	
		Abrasive paper # 240	5	
	TQ12753	Instruction Manual	1	
	TQ12754	Declaration of Conformity	1	

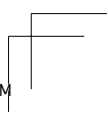
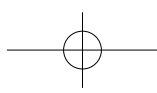
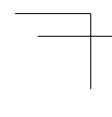
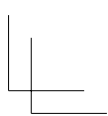
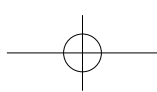



Overseas Affiliates / Offices

NITTO KOHKI U.S.A., INC.
46 Chancellor Drive, Roselle, IL 60172 U.S.A.
Tel:(1)-630-924-9393 Fax:(1)-630-924-0303

NITTO KOHKI EUROPE CO., LTD.
Unit 21, The Empire Centre Imperial Way,
Watford Herts, WD24 4TS, U.K.
Tel:(44)-1-923-239668 Fax:(44)-1-923-248815

NITTO KOHKI DEUTSCHLAND GMBH
Lerchenstr.47 D-71144 Steinenbronn, Germany
Tel:(49)-7-157-22436 Fax:(49)-7-157-22437

NITTO KOHKI CO., LTD., SINGAPORE BRANCH
10 UBI CRESCENT #01-62,
UBI TECHPARK LOBBY D, SINGAPORE 408564,
Tel:(65)-6227-5360 Fax:(65)-6227-0192

NITTO KOHKI AUSTRALIA PTY. LTD.
77 Brandl St., Brisbane Technology Park,
Eight Mile Plains QLD 4113 Australia
Tel:(61)-7-3340-4600 Fax:(61)-7-3340-4640

NITTO KOHKI CO., LTD.,
BANGKOK REPRESENTATIVE OFFICE
M&A Business Center 38Q. House Convent Bldg.,
7th Floor, Unit 7A, Convent Rd., Silom, Bangrak,
Bangkok 10500 Thailand
Tel:(66)-2-632-0307 Fax:(66)-2-632-0308

NITTO KOHKI (SHANGHAI) CO., LTD.
Room1506, suite C, Orient International Plaza,
NO85 LouShanGuan Road,Shanghai, 200336, CHINA
Tel: (86)-21-6415-3935 Fax:(86)-21-6472-6957

NITTO KOHKI CO., LTD.,
SHENZHEN REPRESENTATIVE OFFICE
2005C Shenzhen ICC Tower, Fuhuasanlu 168, Futian District,
Shenzhen, Guangdong, 518048 China
Tel: (86)-755-8375-2185 Fax:(86)-755-8375-2187



NITTO KOHKI Co., Ltd.
2-9-4, Nakaikegami, Ohta-ku, Tokyo, 146-8555, Japan
Tel: (81)-3-3755-1111 Fax (81)-3-3753-8791

EC DECLARATION OF CONFORMITY

We hereby declare that the following our product conforms with the essential health and safety requirements of EU Directives.

Product: HANDY PNEUMATIC SANDER
Model: FREE SANDER: FS-100C,FS-50A
Serial No: In the case of 6 digits serial number.
X X X X X X
Consecutive numbers (00001~99999)
Last digit (0-9) of year (A.D.)
In the case of 7 digits serial number.
X X X X X X X
Consecutive numbers (00001~99999)
Last two digits (00-99) of year (A.D.)
Manufacturer: NITTO KOHKI Co., Ltd.
2-9-4, Nakaikegami, Ohta-ku, Tokyo, 146-8555, Japan
Authorised person to prepare the technical construction file(TCF) in the community:
Masatoshi Ogue
President
NITTO KOHKI EUROPE Co., Ltd.
Unit21, Empire Centre, Imperial Way, Watford Hertfordshire,
WD24 4TS, UK
Tel:(44)-01923-239668 Fax:(44)-01923-248815
Directive: 2006/42/EC Machinery Directive

The above product has been evaluated for conformity with above directives using the following European standards. The technical construction file (TCF) for this product is retained at the above manufacturer's location.

Machinery Directive: EN ISO 12100:2010, EN ISO 11148-8:2012, others
Sound Pressure/Power Level: EN ISO 15744:2008, EN ISO 4871:1996
Vibration Level: EN ISO 28927-3:2009

Signature: [Handwritten Signature]
Date/Place: Jan 15, 2010 /Tokyo, Japan
Name: K.Kishi
Title: GENERAL MANAGER MACHINE TOOLS DIV.
NITTO KOHKI Co., Ltd.
2-9-4, Nakaikegami, Ohta-ku, Tokyo, 146-8555, Japan
Being the responsible person appointed and employed the manufacturer.

TQ12754-1